

Time-Frequency Analysis for Data Perception

Yetmen Wang
AnCAD, Inc.
www.ancad.com.tw

What is frequency?

- Frequency definition
- Fourier glass
- Instantaneous frequency
- Signal composition: trend, periodical, stochastic, and discontinuity

What is frequency?

- The inverse of period. But then what is period?
- Number of times of “happening” in a period. Then what is “happening”? Zero crossing, extrema, or others?
- Fourier transform.

Frequency definition (1)

- Period is defined as number of events in duration of time. And frequency is the inverse of period.
- The concept of period is an average. So do the frequency.
- Since there is no instantaneous period, there is no instantaneous frequency.
- Putting on Fourier glasses, uncertainty principle comes into play for sinusoidal signal. That is, the lower the frequency to be identified, the longer the duration of signal.

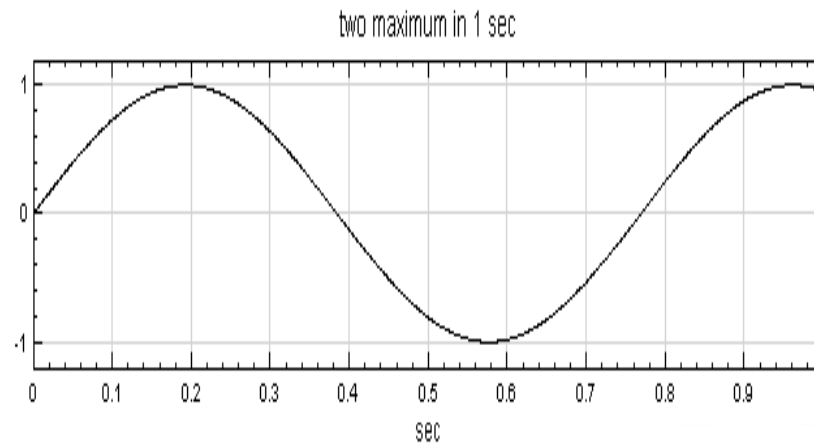
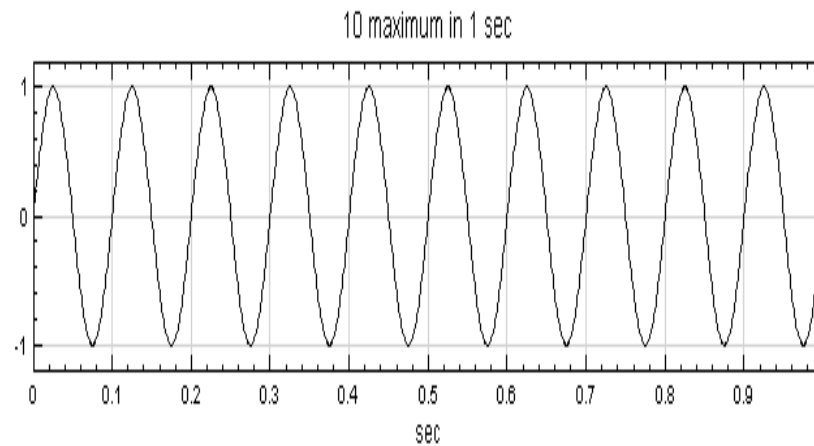

Analogy between velocity and frequency

Average velocity:

$$V_{av} = \frac{\Delta x}{\Delta t}$$



Instantaneous velocity:

$$V_{in} = \frac{dx}{dt}$$

Average frequency:

$$f_{av} = \frac{\Delta N}{\Delta t}$$



What is instantaneous frequency?

$$f_{in} = \frac{d?}{dt}$$

Single frequency?

- Is the squared periodical wave of single frequency?
- With Fourier glasses, sine wave is of single frequency while squared wave is of multiple frequencies.
- What is the definition of frequency?
- What do we want to see?

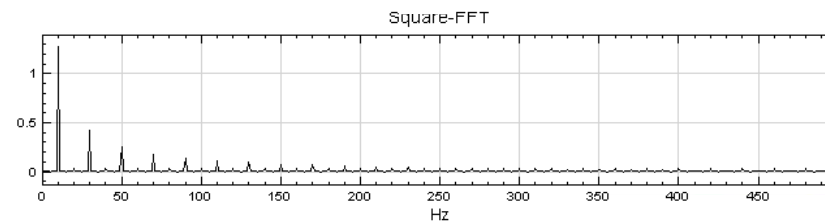
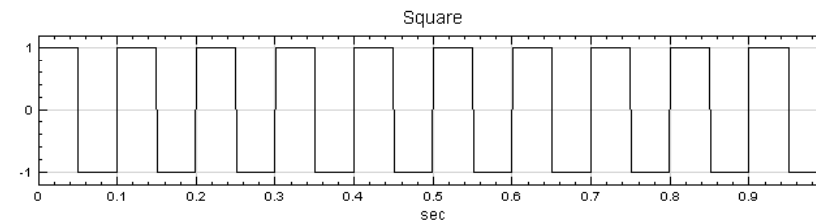
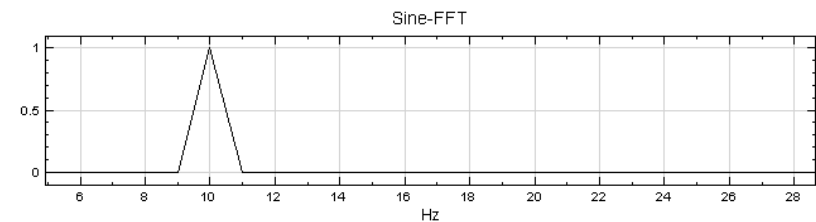
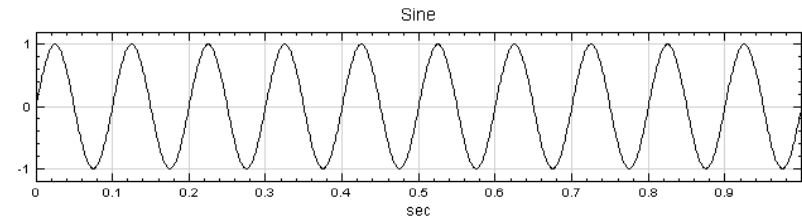

Non-Periodical Signal of many frequencies?

- Does a straight line has a frequency?
- Putting on Fourier glasses, we see so many frequencies from a straight line.
- Again what do we want to see?

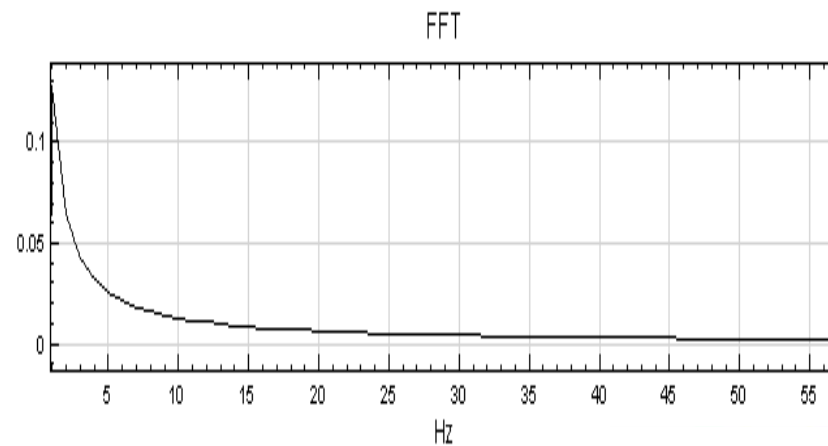
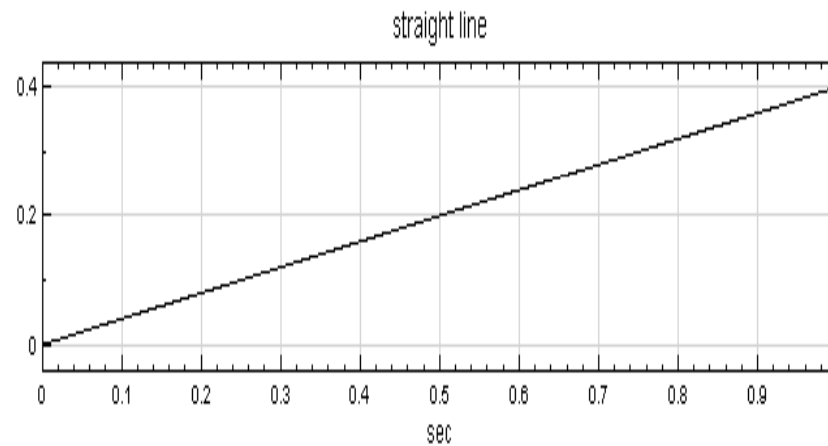

What do we want from frequency?

Data perception

- Signal is normally composed of four parts: trend, periodical, discontinuity(jump, end effect), and stochastic.
- Trend is best perceived in time domain.
- Discontinuity which might result in infinitely many components in Fourier analysis is better eliminated before processing.
- Stochastic part currently is not involved in this discussion.
- Periodical signal can be well perceived in time-frequency-energy representation.

Why Fourier?

1. LTI system
2. Sine/Cosine: Eigen-function of LTI system
3. Frequency: Eigen-value of LTI system

Linear Time Invariant System

- Linear System :

$$\hat{L}(af_1(t) + bf_2(t)) = a\hat{L}f_1(t) + b\hat{L}f_2(t)$$

- Time Invariant:

$$\hat{L}f(t) = h(t)$$

$$\hat{L}f(t - u) = h(t - u)$$

LTI vs. Convolution

$$\hat{L}\delta(t) = G(t)$$

$$\hat{L}f(t) = \hat{L}\int f(u)\delta(u-t)du$$

$$= \int f(u)\hat{L}\delta(u-t)du$$

$$= \int f(u)G(u-t)du$$

$$= f * G$$

Exponential : eigen-function of LTI system

$$\hat{L}e^{j\omega t} = L(\omega)e^{j\omega t}$$

Sin and Cos functions are eigenfunction of LTI system.
Eigenvalue of a LTI system is frequency.

Data Analysis vs Data Processing

Data Analysis

- For understanding
- For discovery
- Find out what's behind the signal.

Data Processing

- For control
- For design
- Find out what model(parameters) best fits the pass behavior.

Sampling:

The connection between continuous and discrete world is via sampling:

$$\bar{f}(t) = \sum_{k=-\infty}^{+\infty} \delta(t - k\Delta t) f_k$$

where

$$f_k = f(k\Delta t)$$

Thru the generalized function theory, weak formulation ensures the mathematical identity.

DFT: zero order integration

- Discrete signal can be written as continuous function with Delta function trains weighted by sampled values. Continuous Fourier transform for the signal results naturally into zero order integration.

$$F_k = \sum_{i=1}^n f_i W^{ik}$$

The accuracy of DFT*

TABLE 5.16.1
Comparison of DFT with Fourier Transform Values

n	$\omega = n\Omega$	$ F(j\omega) $	$T \cdot F_n $ $N = 10, T = \frac{1}{5}$	Percentage Error	$T \cdot F_n $ $N = 20, T = \frac{1}{10}$	Percentage Error
0	0	1	1	0	1	0
1	π	0.636620	0.647214	1.7%	0.639245	0.41%
2	2π	0	0	0	0	0
3	3π	0.212206	0.247212	16.5%	0.2202689	3.8%
4	4π	0	0	0	0	0
5	5π	0.12732	0.20	57.1%	0.1414214	11.1%
6	6π	0	0	0	0	0
7	7π	0.0909457	0.247212	—	0.112232	23.4%
8	8π	0	0	0	0	0
9	9π	0.070735	0.647214	—	0.1012465	43.1%
10	10π	0	1	—	0	0
11	11π	0.057874	0.647214	—	0.1912465	—
12	12π	0	0	0	0	0

*Fold-over frequency of spectrum. See Figure 5.16.4.

*Extracted from “Signal And Linear System”, p331



The accuracy of DFT*

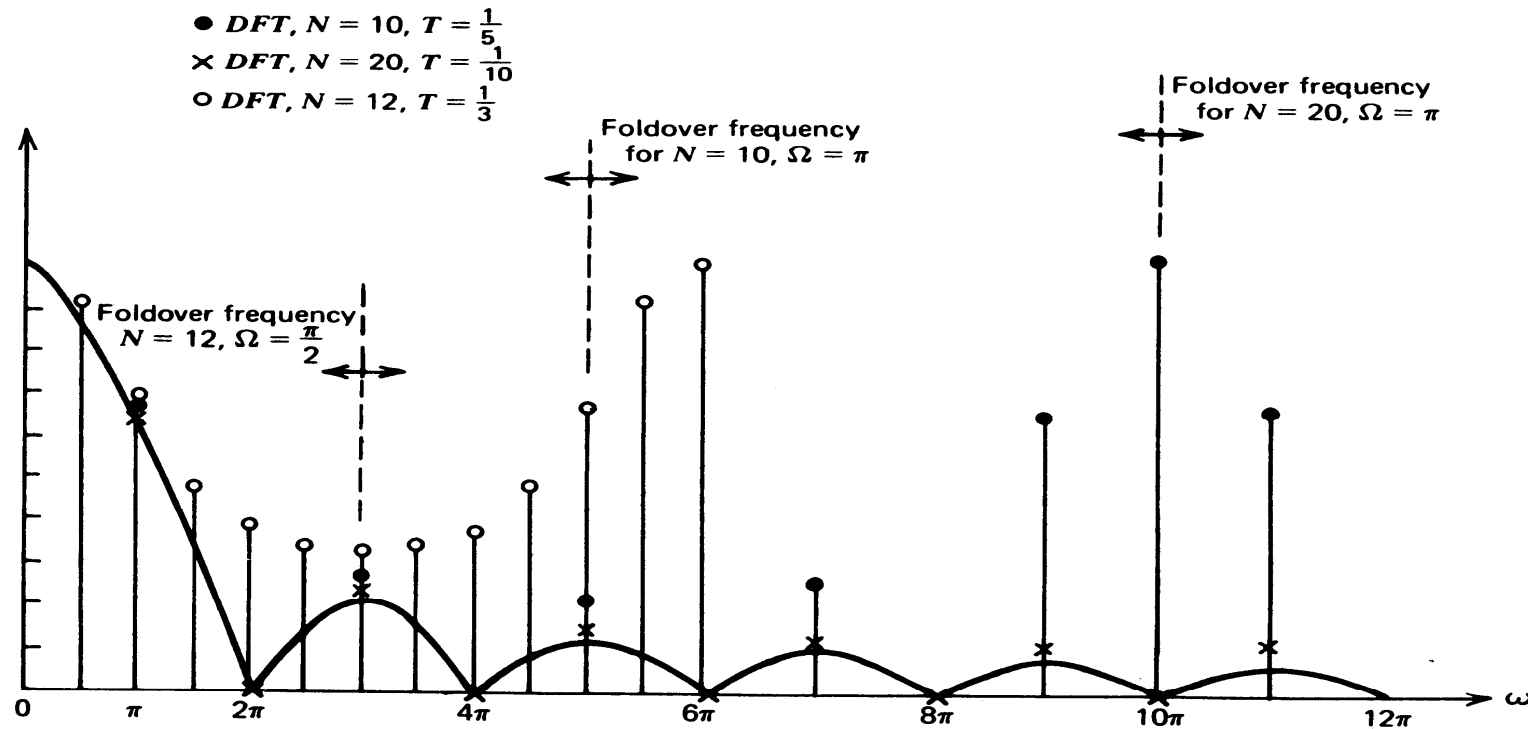
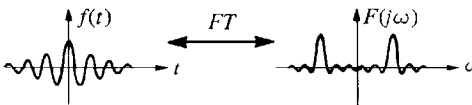
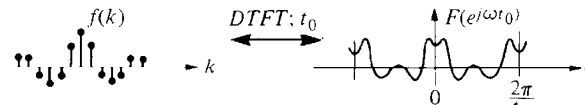
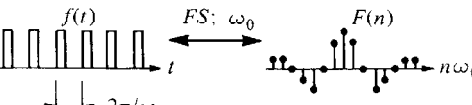
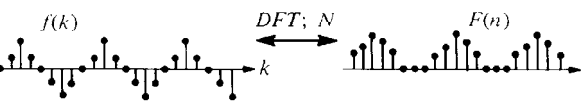

FIGURE 5.16.4 Comparison of DFT calculation with the true Fourier integral spectrum.

*Extracted from "Signal And Linear System", p331

Time vs Frequency*

	Continuous in time	Discrete in time – Periodic in frequency
Continuous in frequency	 $f(t) = \frac{1}{2\pi} \int_{-\infty}^{\infty} F(j\omega) e^{j\omega t} d\omega$ $F(j\omega) = \int_{-\infty}^{\infty} f(t) e^{-j\omega t} dt$ <p>Fourier transform</p>	 $f(k) = \frac{t_0}{2\pi} \int_{-\pi/t_0}^{\pi/t_0} F(e^{j\omega t_0}) e^{jk\omega t_0} d\omega$ $F(e^{j\omega t_0}) = \sum_{k=-\infty}^{\infty} f(k) e^{-jk\omega t_0}$ <p>Discrete-time Fourier transform</p>
Discrete in frequency – Periodic in time	 $f(t) = \sum_{n=-\infty}^{\infty} F(n) e^{jn\omega_0 t}$ $F(n) = \frac{\omega_0}{2\pi} \int_{-\pi/\omega_0}^{\pi/\omega_0} f(t) e^{-jn\omega_0 t} dt$ <p>Fourier series</p>	 $f(k) = \frac{1}{N} \sum_{n=0}^{N-1} F(n) (e^{j2\pi/N})^{kn}$ $F(n) = \sum_{k=0}^{N-1} f(k) (e^{j2\pi/N})^{-kn}$ <p>Discrete Fourier transform</p>

*Extracted from “Digital Signal Processing” by Roberts & Mullis



Time vs Frequency

Time domain

- Continuous
- Periodical (finite length)
- Discrete (sampling)

Frequency domain

- Continuous
- Discrete (sampling)
- Periodical (finite length)

Fourier Transform

Continuous in Time

Continuous in Frequency

$$F(\omega) = \int_{-\infty}^{+\infty} f(t) e^{-j\omega t} dt$$

$$f(t) = \frac{1}{2\pi} \int_{-\infty}^{+\infty} F(\omega) e^{j\omega t} d\omega$$

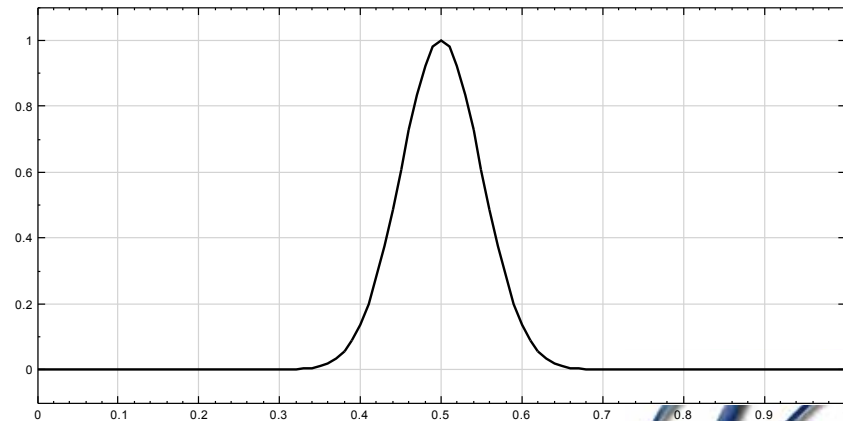
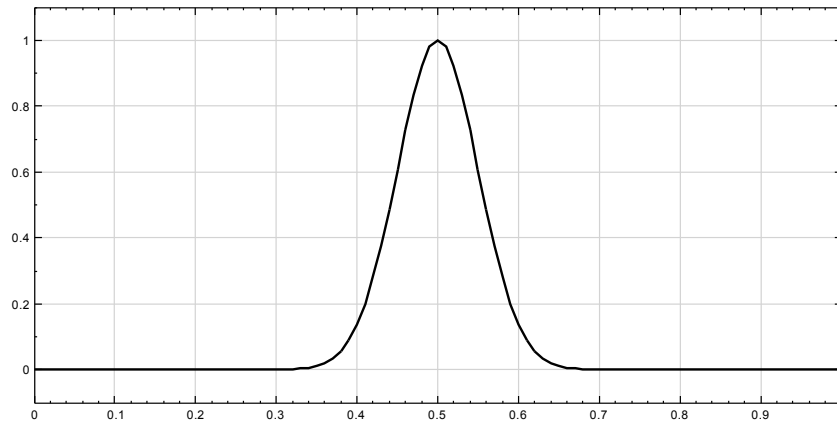

Discrete in Time Fourier Transform (DTFT)

Discrete(sampling) in time Periodical in frequency

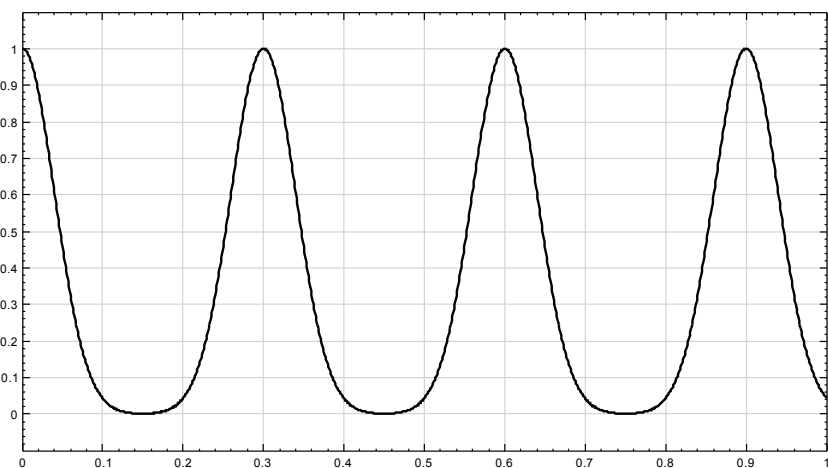
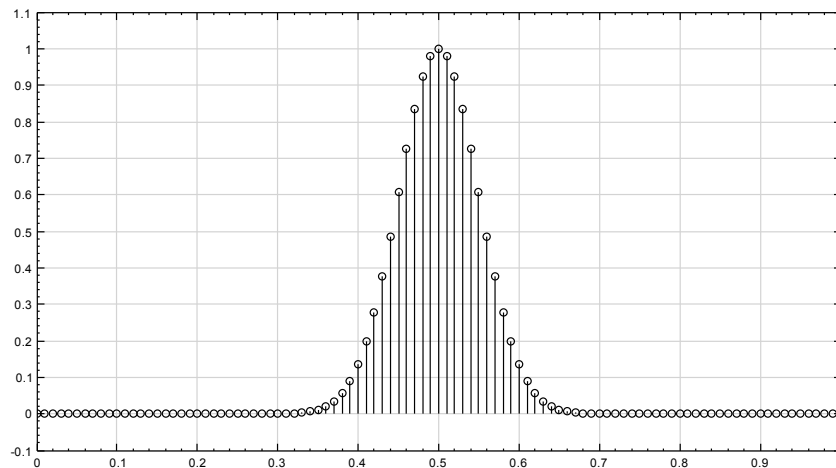

Aliasing

1. What is aliasing?
2. Aliasing effect in time-frequency plot.
3. How to avoid aliasing?

Aliasing

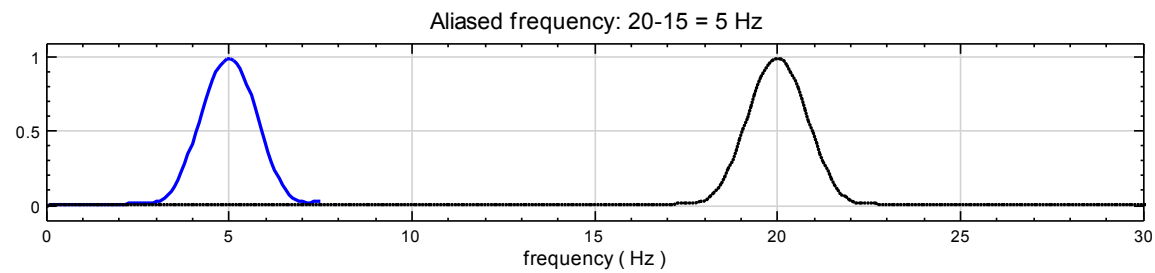
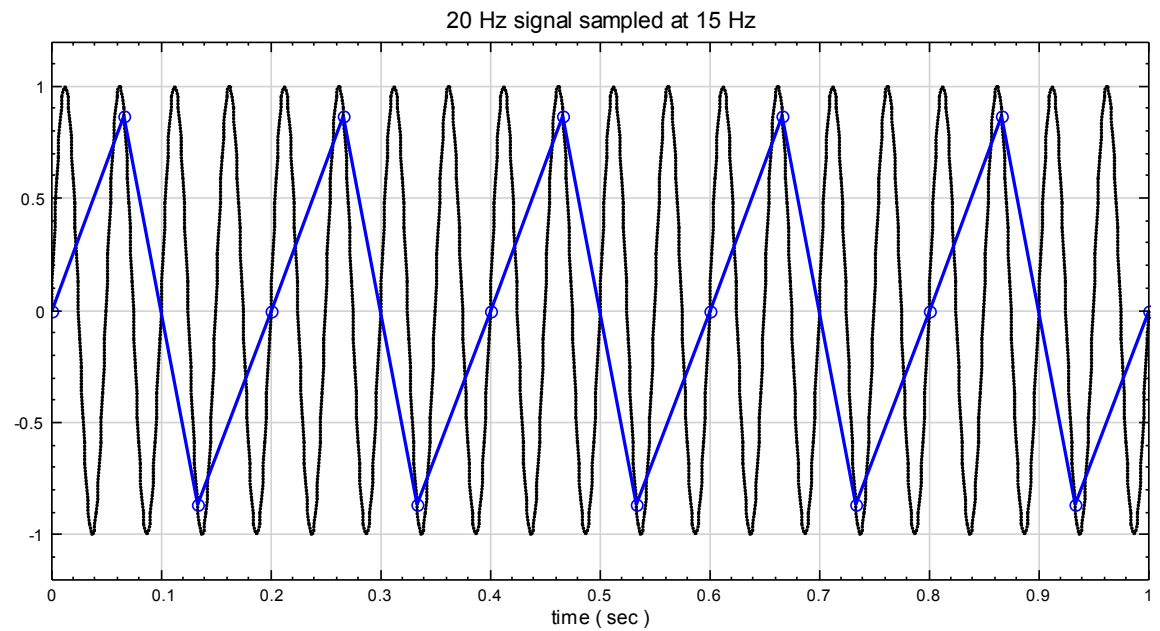

Source signal: $\sin(2\pi \cdot 10 \cdot t^3)$
Sample rate: 1000Hz

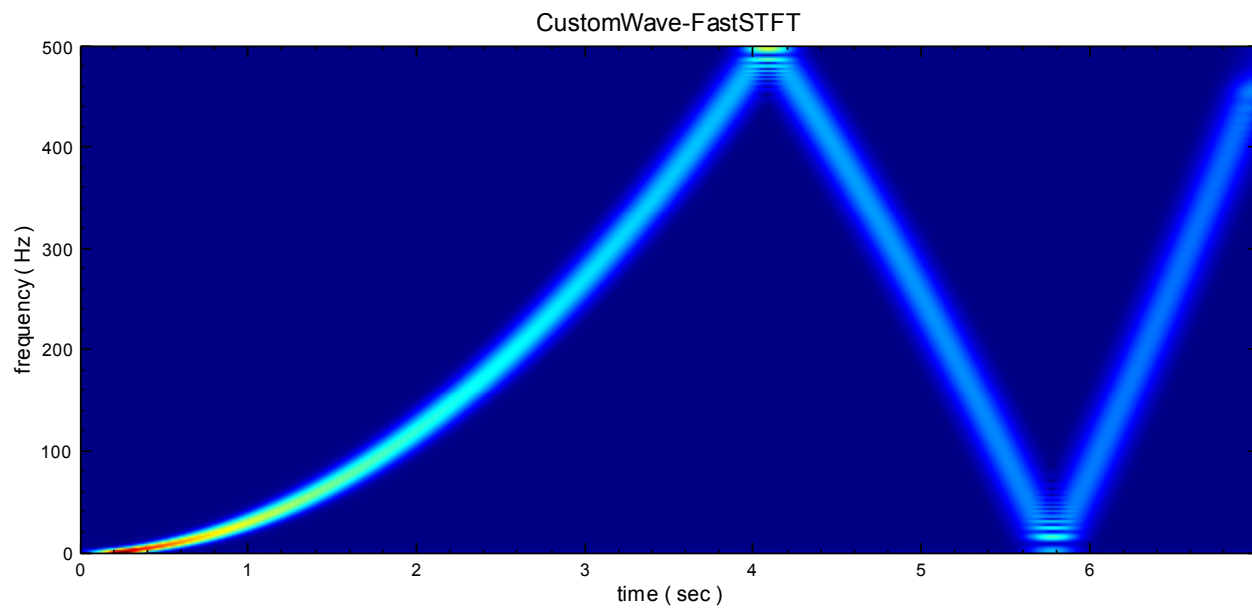
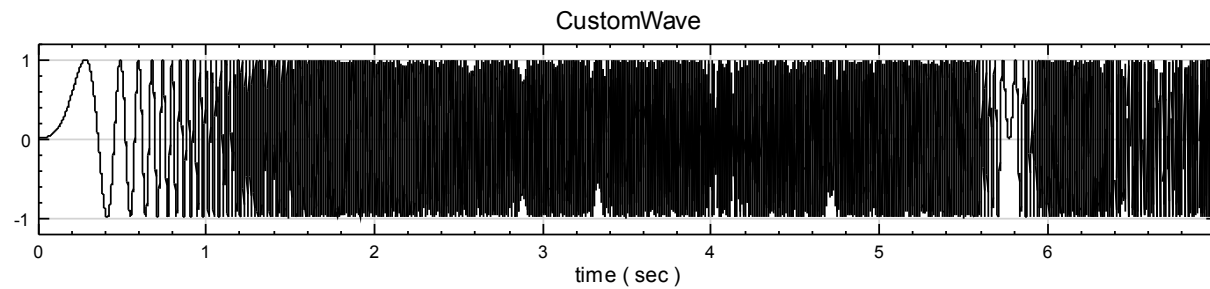

Down sampled (2sec,10sec,100sec)

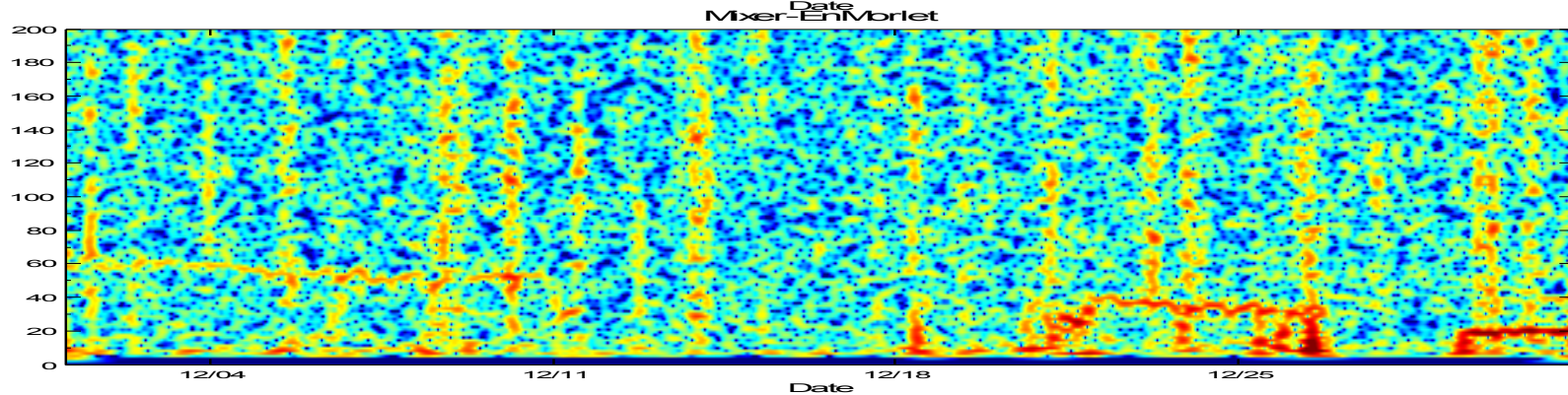
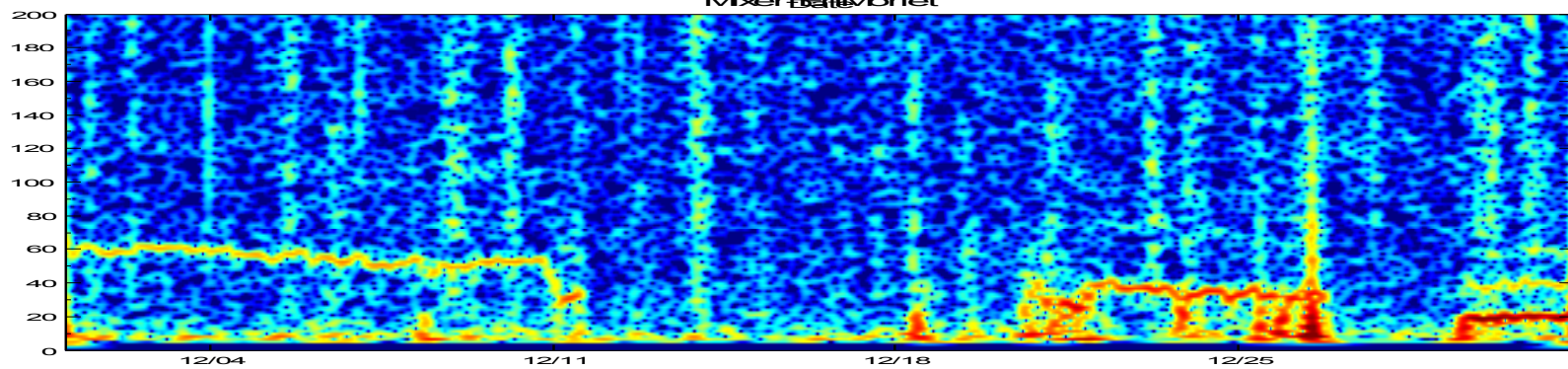
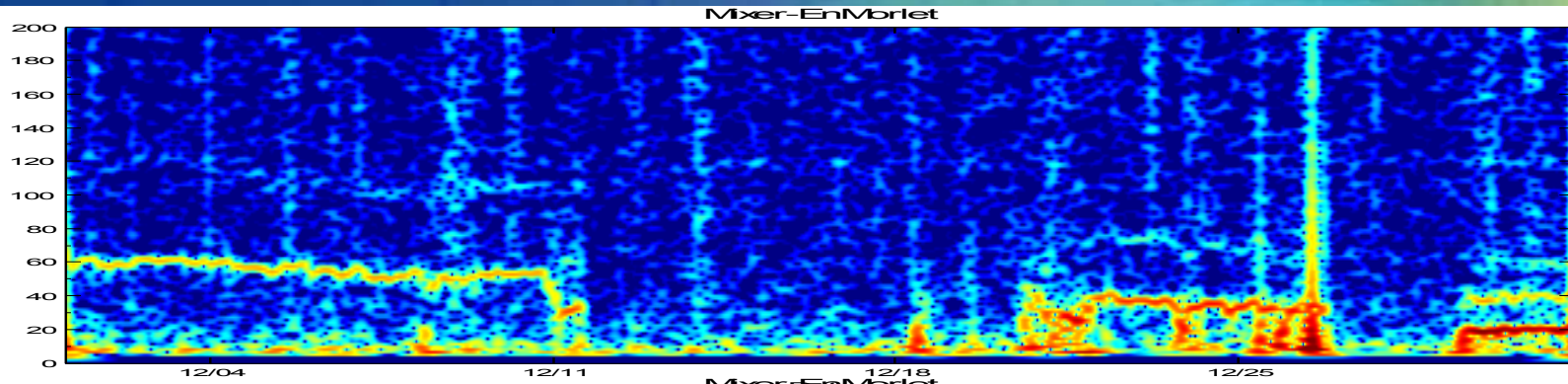

Aliasing effect in accelerometer signal

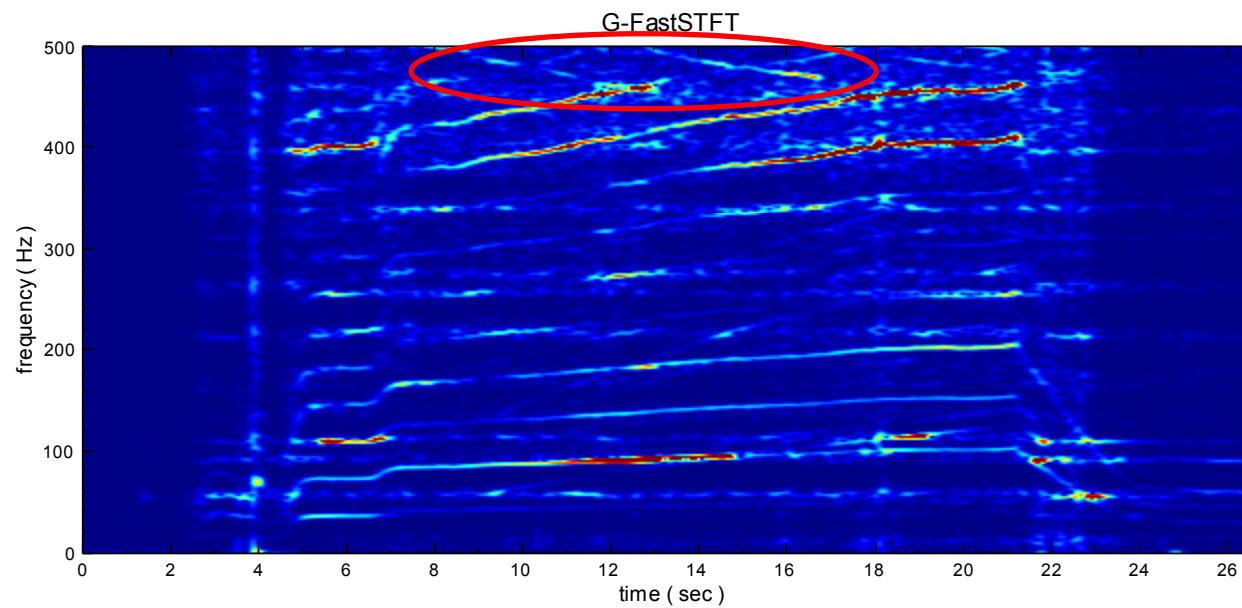
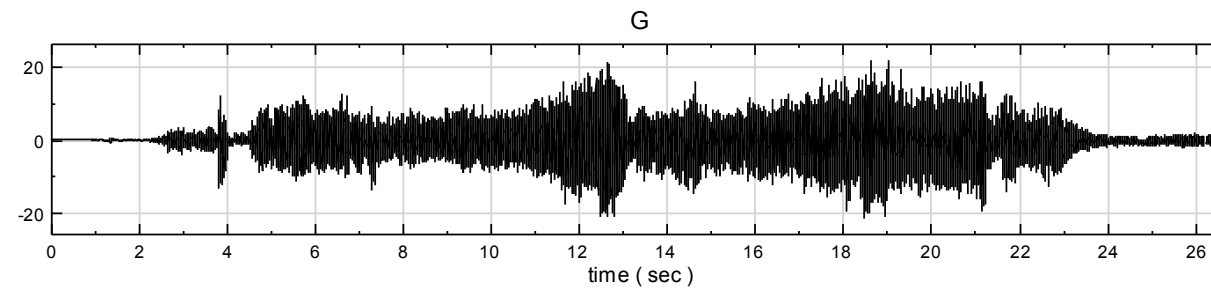

Anti-Aliasing

- Do low pass filter on analog signal before sampling. (This is done normally using analog circuit. For advanced data acquisition system, the function is a built-in feature.) If the frequency of interest is say F_c , signal of frequency higher than F_c should be eliminated.
- Digitize signal with sampling rate higher than Nyquist frequency $2F_c$. (According to sampling theory, information will be lost for sampling rate lower than the Nyquist frequency. In practice, sampling should be much higher than Nyquist frequency. In practice, we suggest sampling rate be more than 20 times the frequency of interest F_c .)

Uncertainty Principle

Simultaneously Determine Time and Frequency

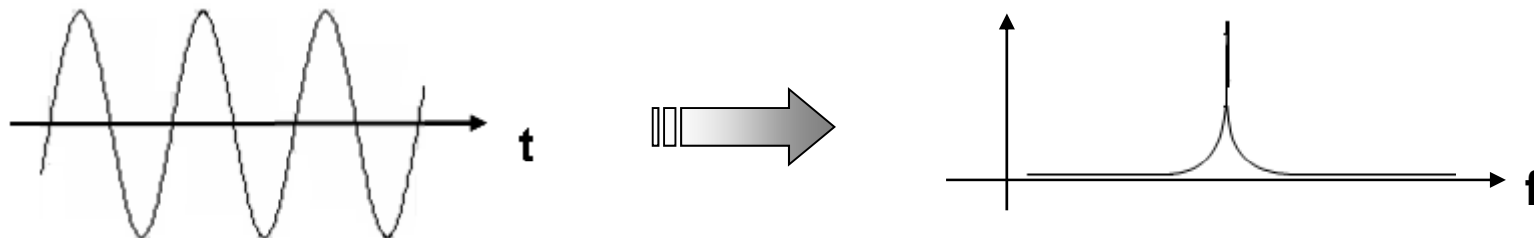
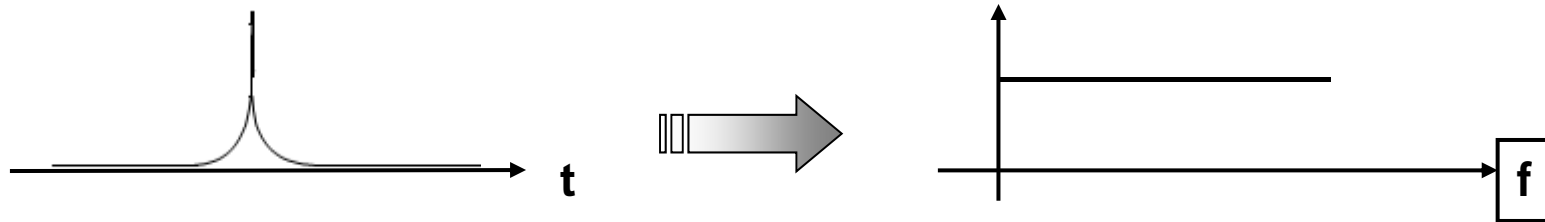

Time and Frequency Resolutions

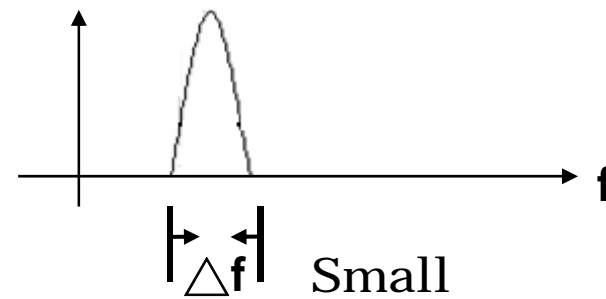
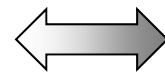
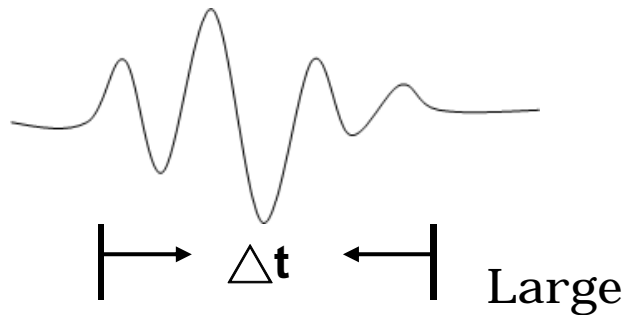
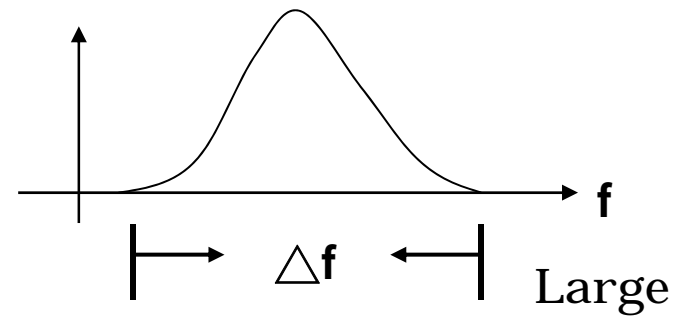
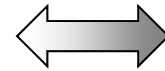
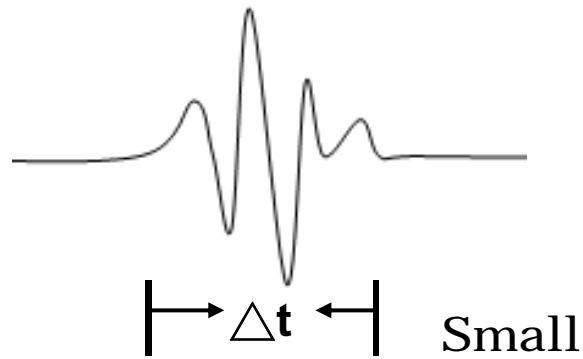

Formula

$$t_0 = \frac{1}{\|g(t)\|^2} \int_{-\infty}^{\infty} t |g(t)|^2 dt \qquad \omega_0 = \frac{1}{\|G(\omega)\|^2} \int_{-\infty}^{\infty} \omega \|G(\omega)\|^2 d\omega$$

$$\Delta t^2 = \frac{1}{\|g(t)\|^2} \int_{-\infty}^{\infty} (t - t_0)^2 |g(t)|^2 dt$$

$$\Delta \omega^2 = \frac{1}{\|G(\omega)\|^2} \int_{-\infty}^{\infty} (\omega - \omega_0)^2 |G(\omega)|^2 d\omega$$

$$\Rightarrow \Delta t \Delta \omega \geq \frac{1}{2}$$

Equality holds when

$$g(t) \sim e^{-t^2/4\alpha^2 + j\beta t}$$

Removal of Non-Periodical Signal

Frequency based filter
Iterative Gaussian Filter
EMD as filter

Is Taipei getting warmer?

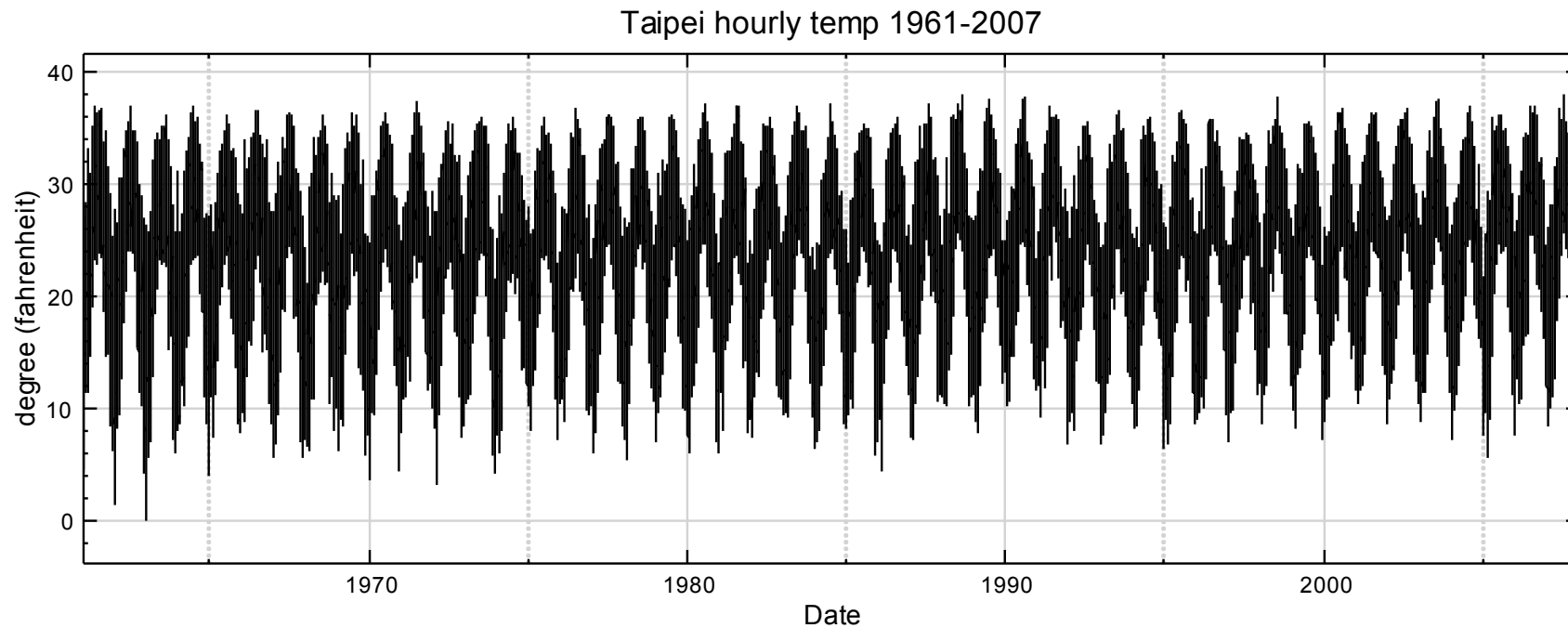

Trend Removal

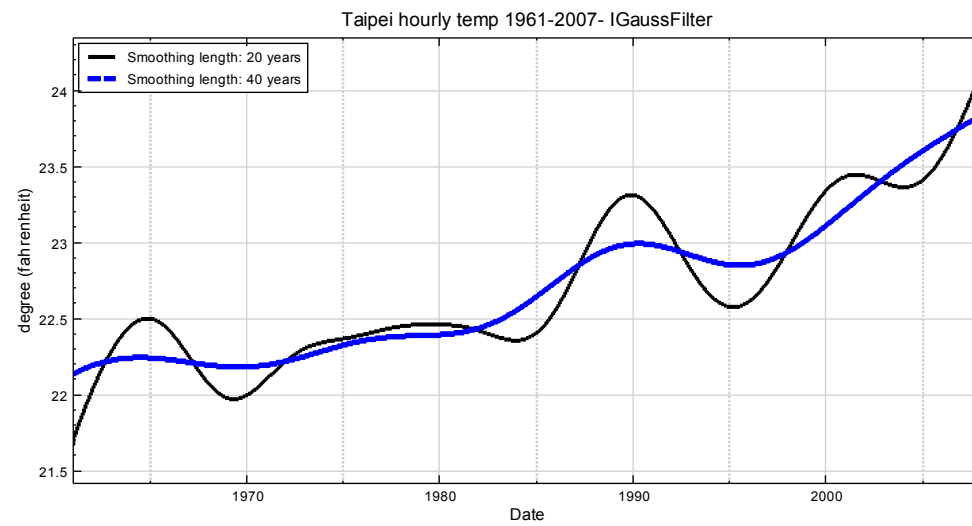
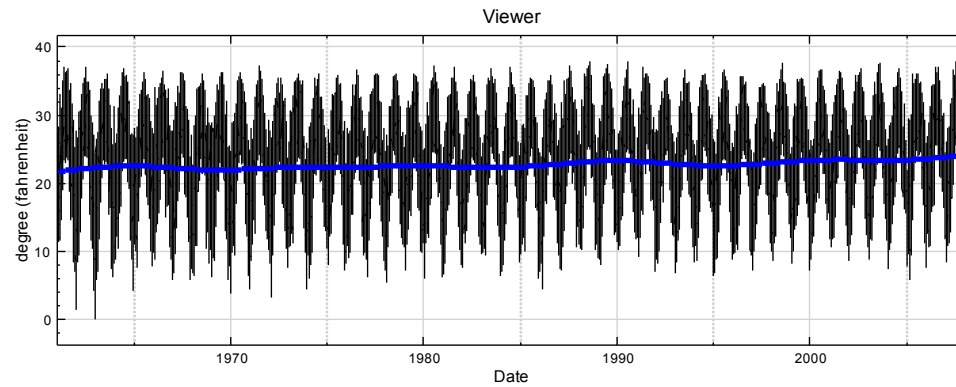

Trend embedded in signal of interest

- Do we have noise signal of low frequency?

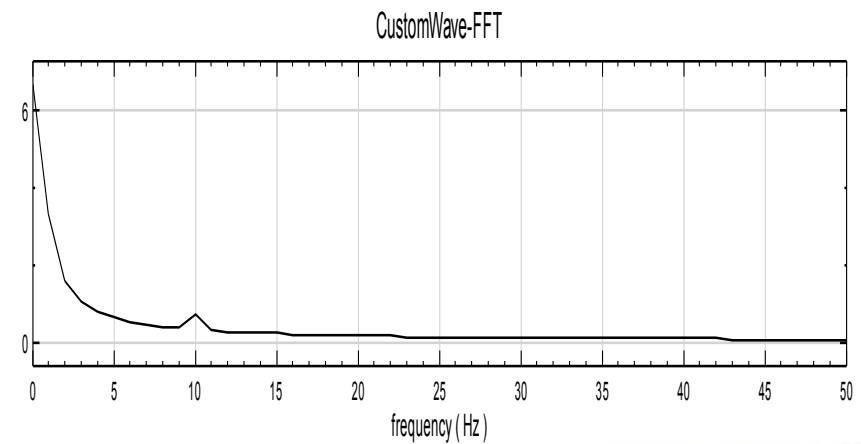
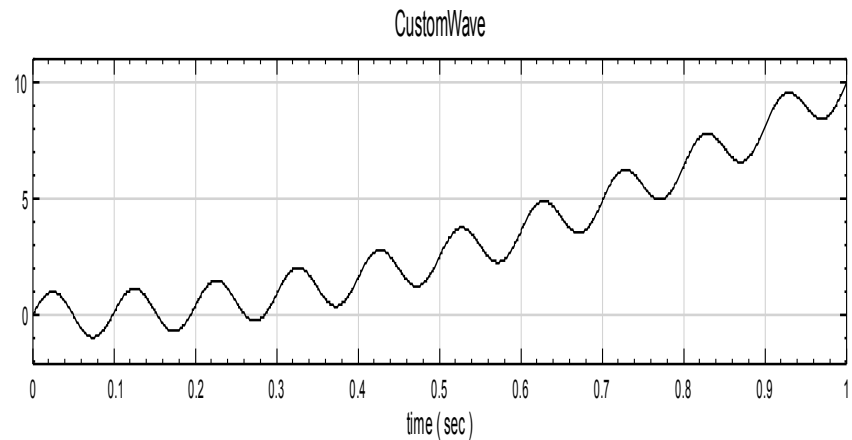

EMD for trend removal

- EMD is also a good way to separate trend signal.

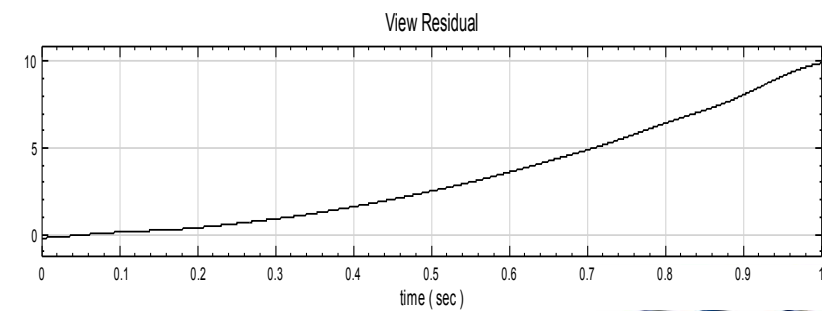
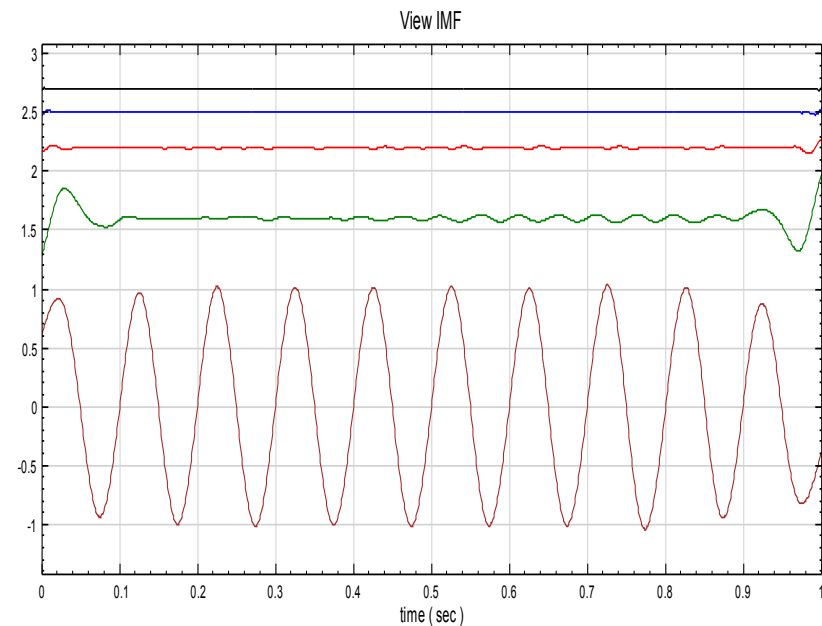

Moving Average

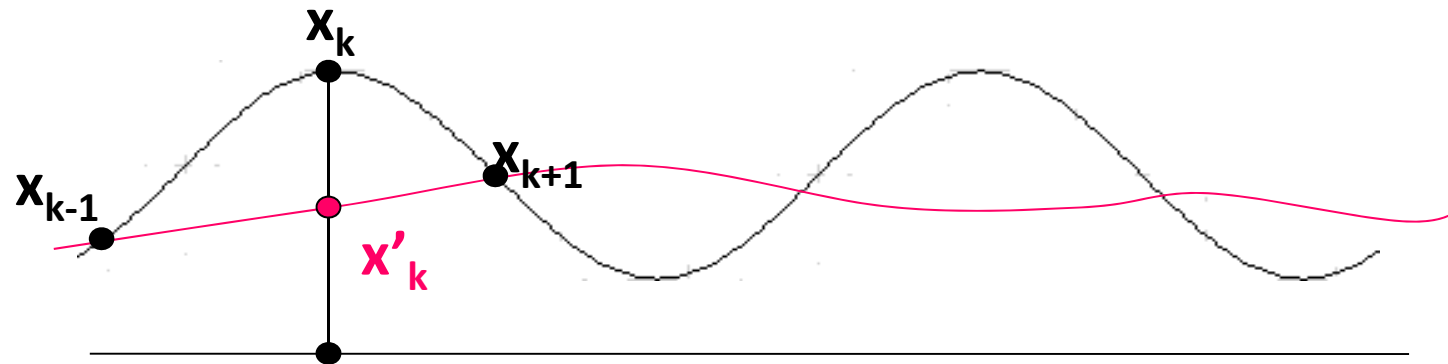

Smooth curve can be obtained by moving average:

$$x'_k = (x_{k-1} + x_k + x_{k+1}) / 3$$

In general number of point average can be many with Gaussian weighting.

$$x'_k = A \sum_j x_{k-j} \exp\left(-\frac{(k-j)^2}{2\sigma^2}\right)$$

Gaussian Filter and Heat Diffusion

For continuous signal, Gaussian filter is written as

$$u'(t) = A \int u(\tau) \exp\left(-\frac{(t-\tau)^2}{2\sigma^2}\right) d\tau$$

It is the solution of the following heat equation

$$\frac{\partial u}{\partial t} = \alpha \frac{\partial^2 u}{\partial x^2} + \delta(t)$$

The analogy suggests that diffusion effect results in smoothing of signal (temperature).

Gaussian Filter

- Iterative moving least square method
- Zero phase error
- Fast algorithm developed by Prof. Cheng of NCKU.
- Continuous signal with trend can be written in the form:

$$x(t) = \sum_{k=1}^n a_k \cos \omega_k t + b_k \sin \omega_k t + \sum_{i=0}^m \alpha_i t^i$$

For each iteration of Gaussian filter, polynomial order m is reduced by 2.

- Gaussian function is the fundamental solution to heat equation. The idea of smoothing is similar to the mechanism of heat spreading, regarding signal as unbalanced temperature distribution to begin with.

Iterative Gaussian Filter

- For continuous signal, its Fourier representation is

$$f(t) = \frac{1}{2\pi} \int_{-\infty}^{+\infty} F(\omega) e^{j\omega t} d\omega$$

Gaussian filter is the weighted average with Gaussian as the weighting function

$$f_L(t) = \frac{1}{c(\sigma)} \int_{-\infty}^{+\infty} e^{-\frac{(t-\tau)^2}{\sigma^2}} f(\tau) d\tau$$

where

$$c(\sigma) = \int_{-\infty}^{+\infty} e^{-\frac{t^2}{\sigma^2}} dt = \sigma\sqrt{\pi}$$

Iterative Gaussian Filter

- After m times of iteration, filtered signal is represented as

$$f_L^m(t) = \frac{1}{2\pi} \int_{-\infty}^{+\infty} \left[1 - \left(1 - e^{-\frac{1}{4}\omega^2\sigma^2} \right)^m \right] F(\omega) e^{j\omega t} d\omega$$

Iterative Gaussian Filter

After m times of iteration, the transfer function becomes:

$$T(\omega) = 1 - \left(1 - e^{-\frac{1}{4}\omega^2\sigma^2} \right)^m$$

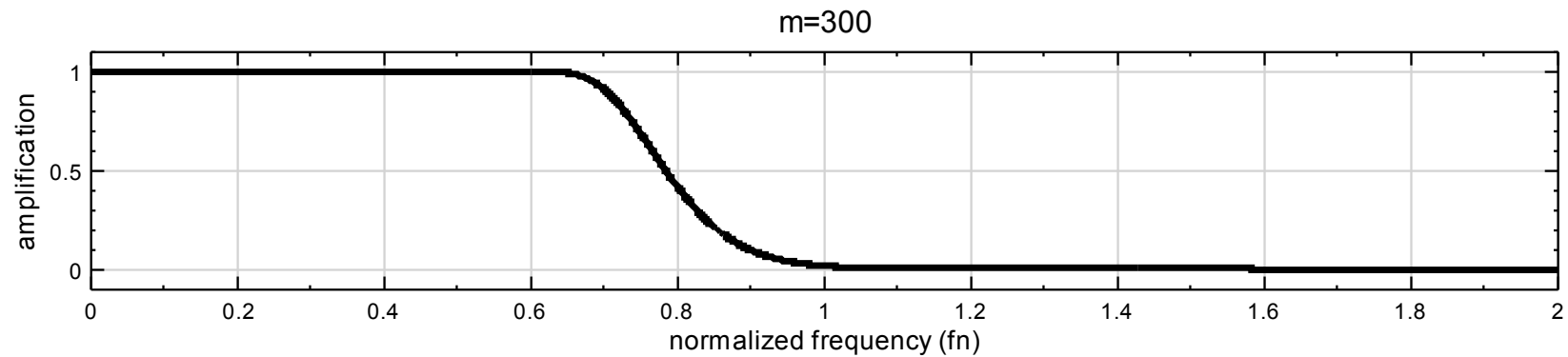

Iterative Gaussian Filter

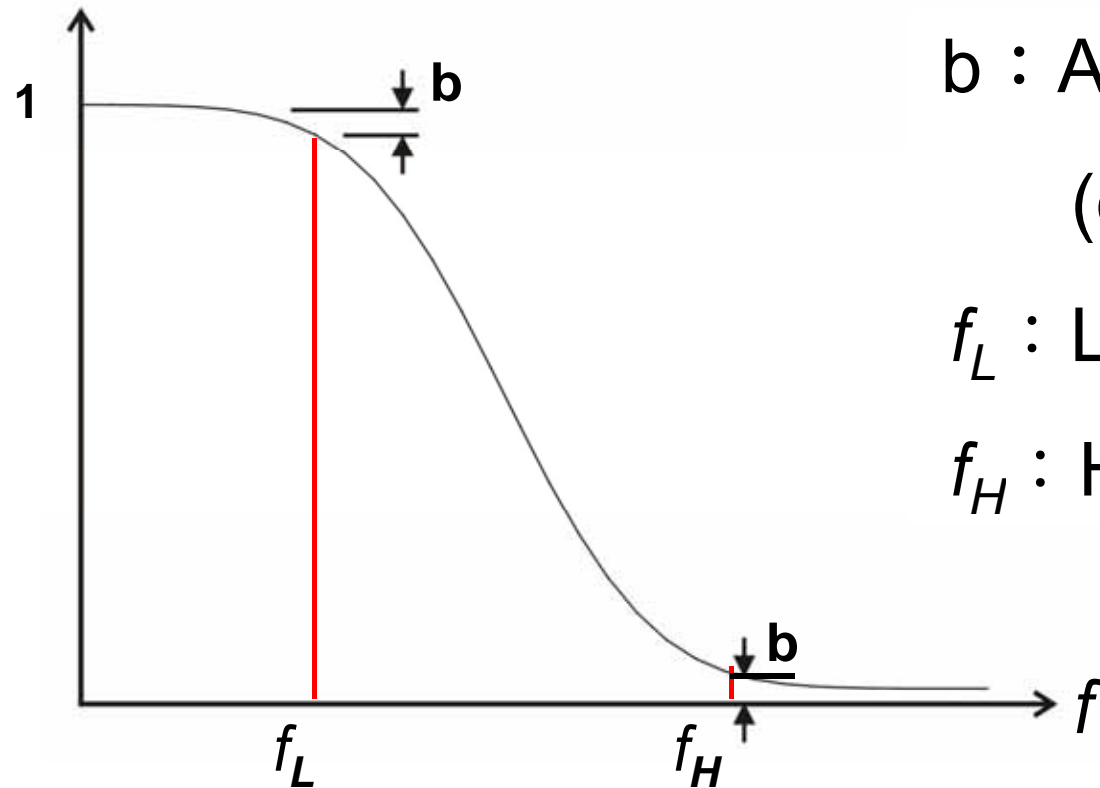

b : Attenuation factor

(e.g. $b=0.01$)

f_L : Low frequency

f_H : High frequency

Iterative Gaussian Filter

- The Gaussian factor, σ , and number of iteration, m , are determined via solving

$$1 - \left[1 - e^{-2\pi^2 (\sigma f_L)^2} \right]^m = b$$

$$1 - \left[1 - e^{-2\pi^2 (\sigma f_H)^2} \right]^m = 1 - b$$

Trend Estimator

T_C (Trend period) : For low pass filter, period lower than the value will be annihilated. In practice T_C is approximately the length of “bump” (half wavelength) under which will be eliminated.

Cutoff frequency

$$f_C = \frac{2}{T_C}$$
$$f_L = \frac{2}{T_C}$$
$$f_H = 2f_L$$

Number of iteration

$$m = 33$$

Time-frequency analysis and instantaneous frequency

1. What is time-frequency analysis?
2. The need for instantaneous frequency
3. Methods used for time-frequency analysis

TF Plot: Single frequency

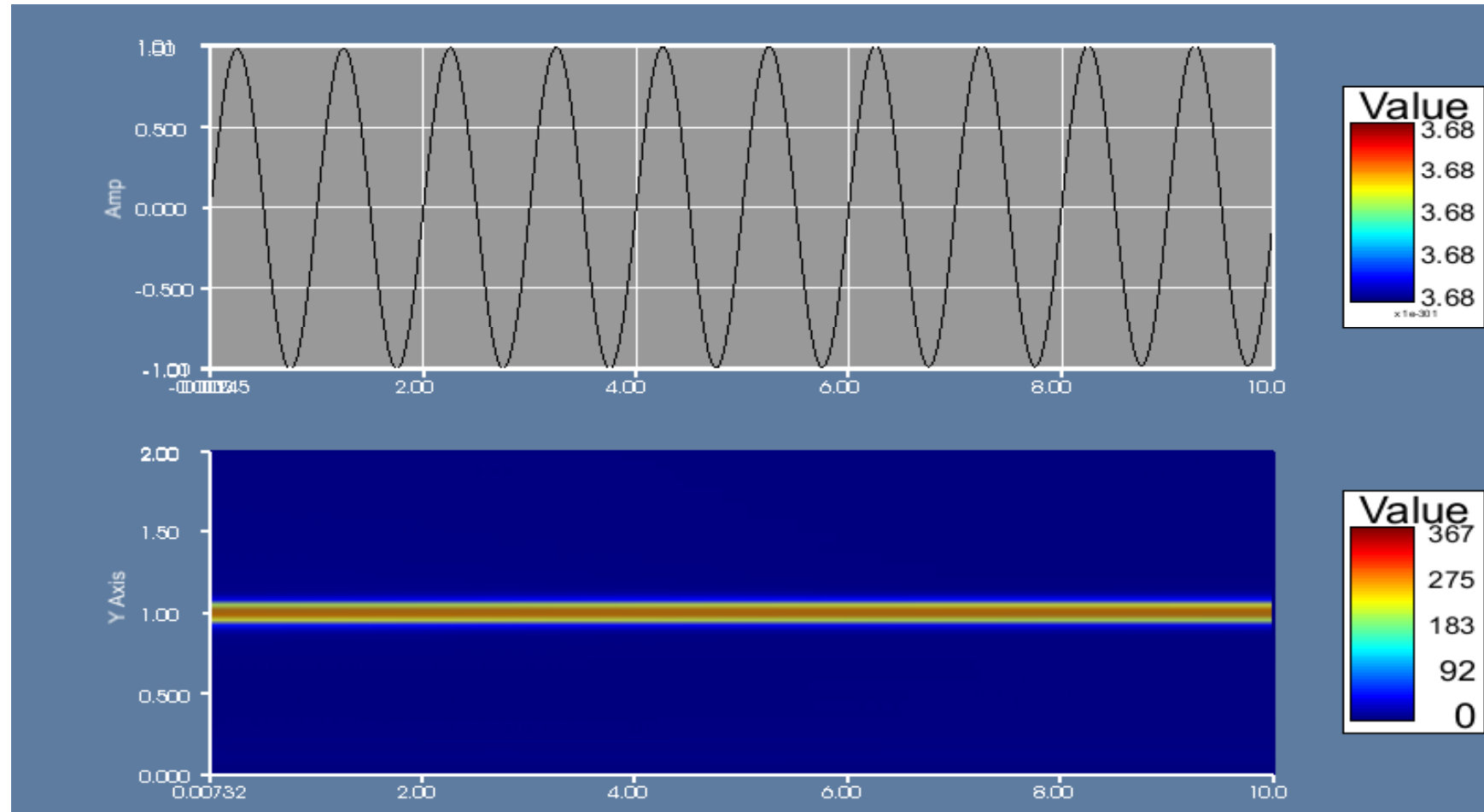

TF Plot: Change of frequency

- Signal with abrupt change of frequency.

$$x(t) = \begin{cases} 0.30 \cos(2 \times 10\pi t) & , 0 \leq t < 1 \\ 0.30 \cos(2 \times 20\pi t) & , 1 \leq t < 2 \end{cases}$$

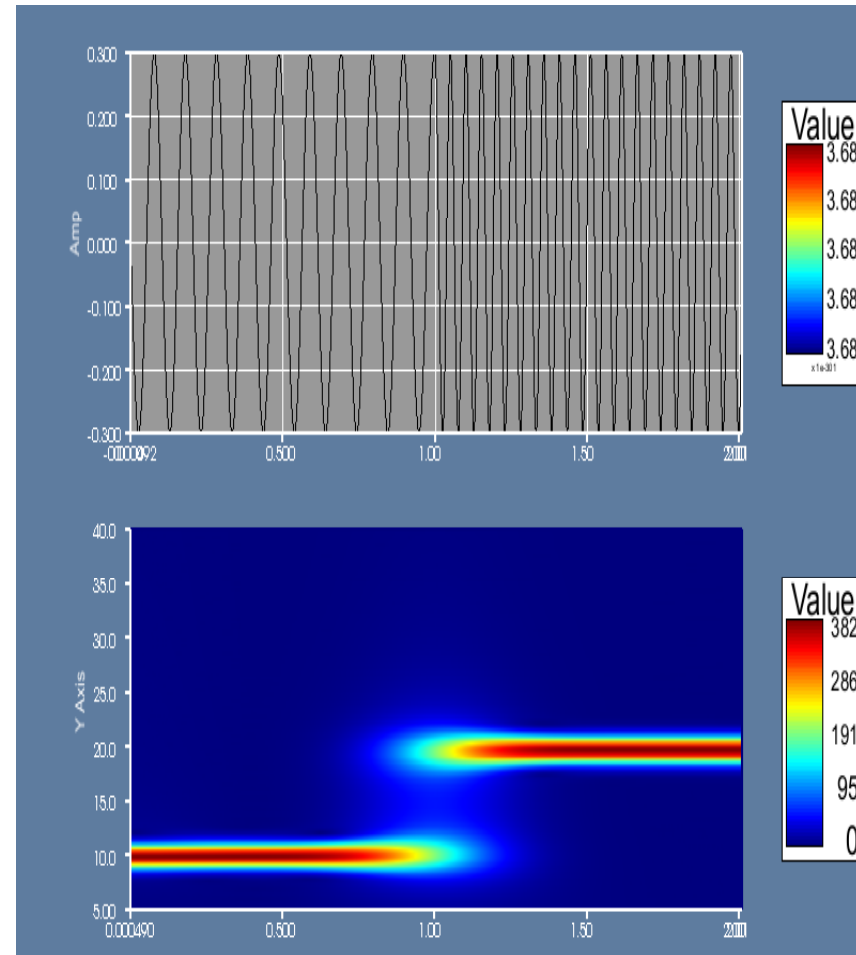

TF Plot: Change of frequency and amplitude

- Signal with abrupt change of frequency and amplitude

$$x(t) = \begin{cases} 0.30 \cos(2 \times 10\pi t) & , 0 \leq t < 1 \\ 0.15 \cos(2 \times 20\pi t) & , 1 \leq t < 2 \end{cases}$$

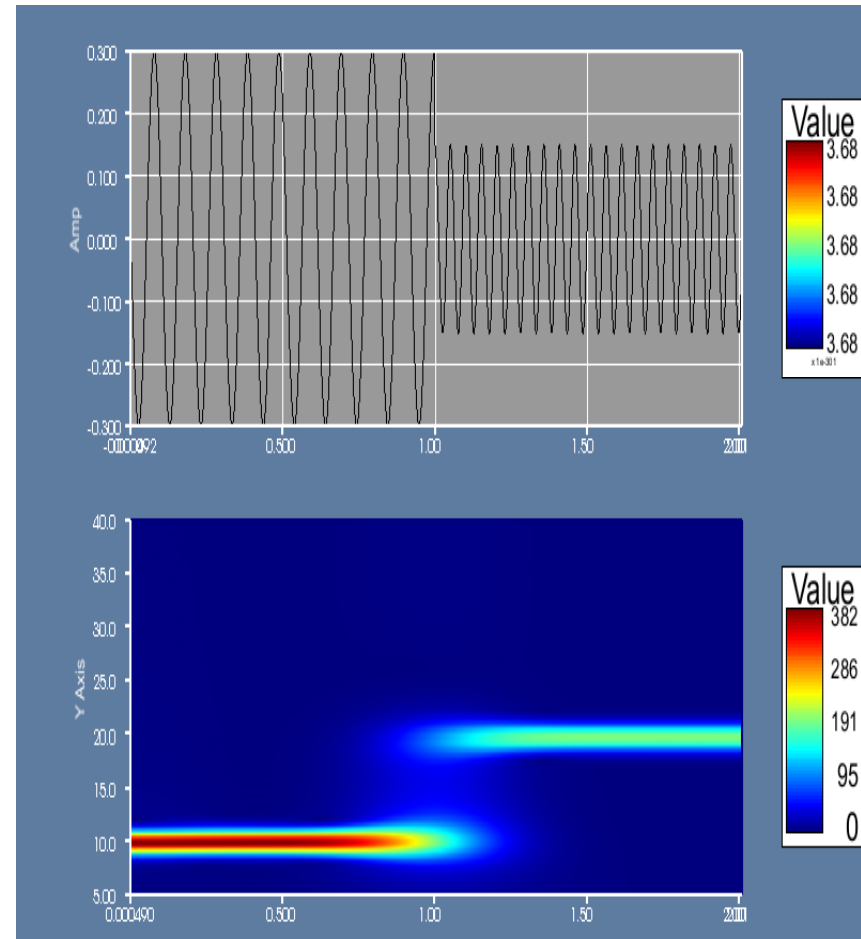

Time-Frequency Analysis Comparison

	Fourier Transform	STFT	Morlet / Enhanced Morlet	Hilbert Transform	HHT
Instantaneous frequency	n/a	distribution	distribution	Single value	Discrete values
Frequency change with time	no	yes	yes	yes	yes
Frequency resolution	good	ok	ok/good	good	good
Adaptive base	no	no	no	n/a	yes
Handling non-linear effect	n/a	no	no	yes	yes

Short-Term Fourier Transform

- Frequency at a certain time is a distribution obtained from Fourier transform. The short period of signal applied to the Fourier transform contains the specific moment of interest.
- In time-frequency analysis, such idea evolves as the Short-Term Fourier Transform (STFT).

STFT:

$$F(t, \omega) = \int_{-\infty}^{+\infty} f(\tau)g(\tau - t)e^{-i\omega\tau} d\tau$$

Note g is a windowing function.
For Gaussian window, the transform is also known as Gabor Transform.

Challenges in STFT

- Catching low frequency component needs longer time.
- Windowing is needed to avoid end effects.

=> STFT is suitable for band-limited signal like speech and sound.

Morlet Transform

- Scale property in signal is related to frequency property when mother wavelet is Morlet..
- Longer duration of wavelet is used to catch lower frequency component.

$$F(t, s) = \int_{-\infty}^{+\infty} f(\tau) \frac{1}{\sqrt{s}} \psi^* \left(\frac{\tau - t}{s} \right) d\tau$$

Morlet transform

- Morlet transform on a chirp signal.
- In catching the high frequency spectrum, mother wavelet of short duration of time is used. The spectrum of such wavelet suffers from wide span of frequency, resulting in low resolution, as shown in the right left plot.

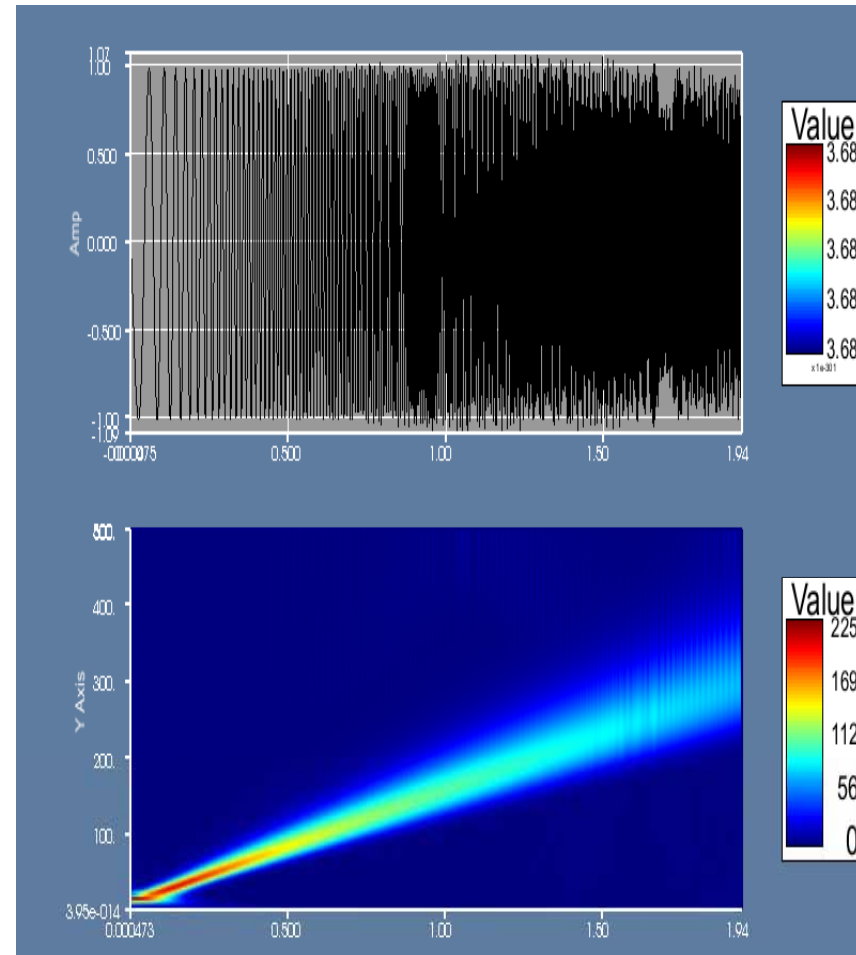

Enhanced Morlet Transform

- By applying Gaussian windowing in frequency domain and knowing that the crossed term of convolution between mother wavelet and signal is the cause of blur, the resolution of Morlet transform can be greatly improved by neglecting the crossed term.
- The fine structure appears in high frequency region is caused by under sampling. The chirp signal is digitized with constant sampling rate.

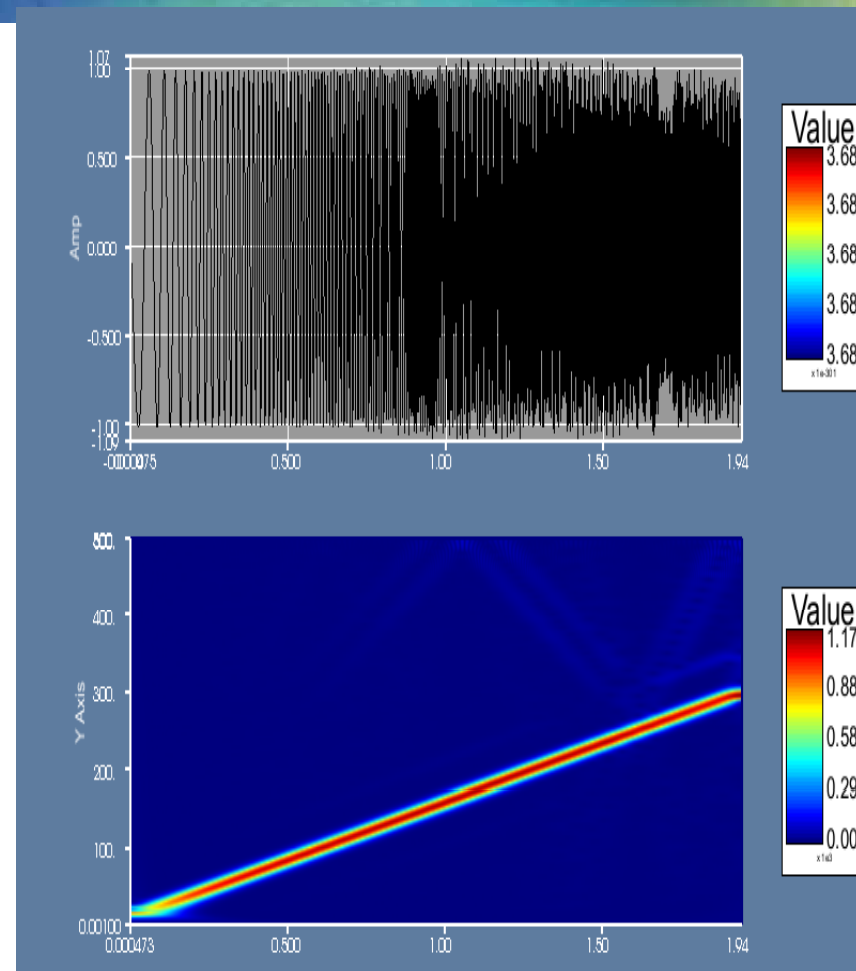

Chirp signal with higher sampling rate

- With higher sampling rate, the fine structure in TF plot disappeared. This is to assure the fine structure pattern is caused by under sampling.

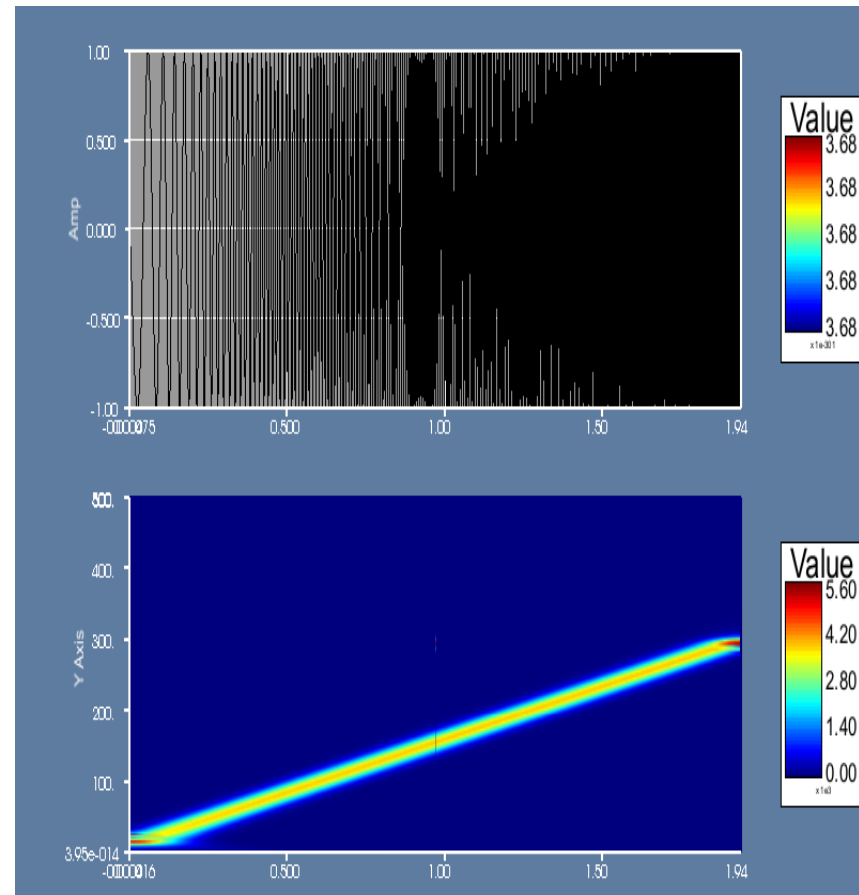

Time-Frequency Resolution

Heisenberg Box

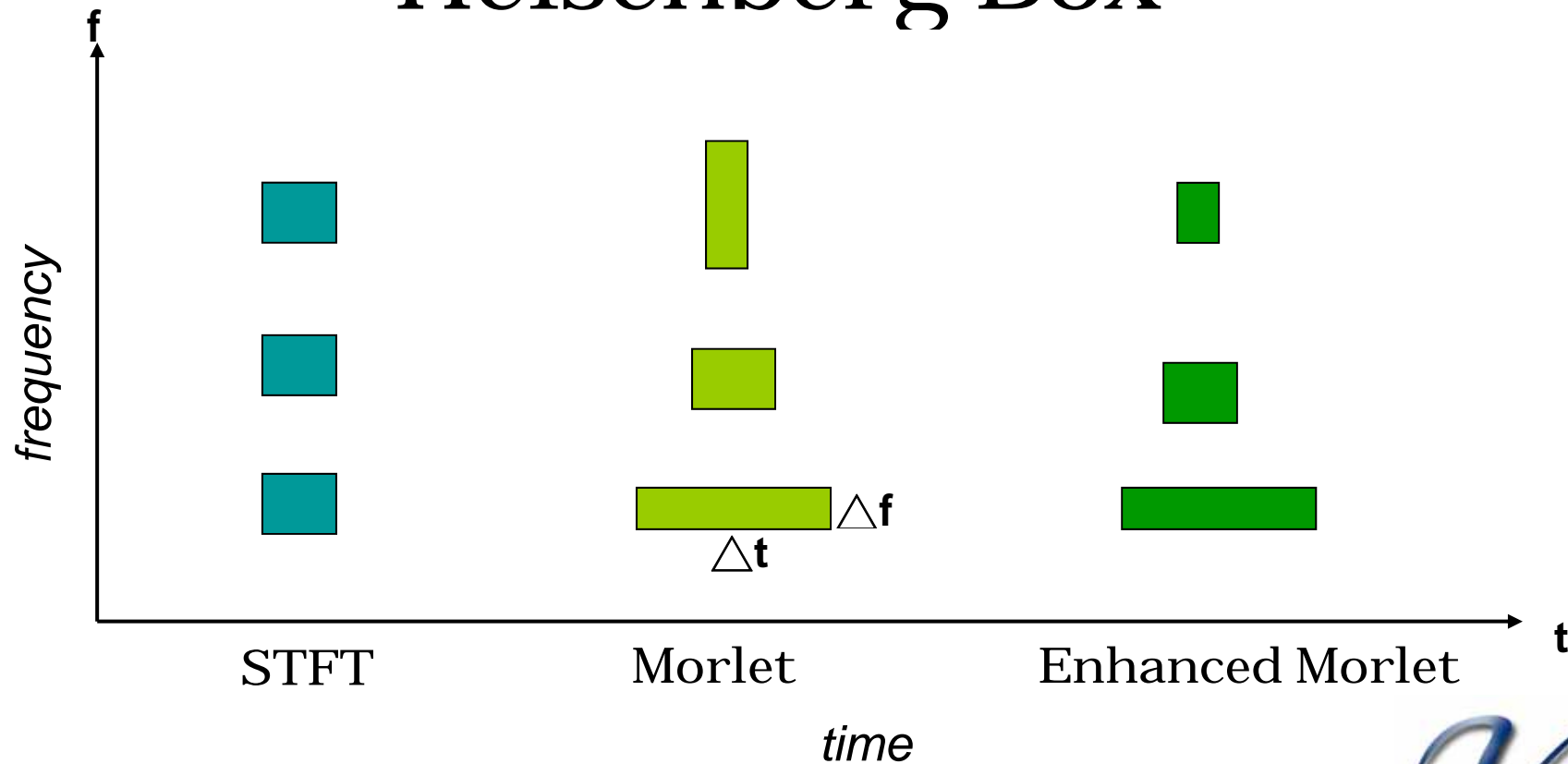

Primary vs. Nature Frequency

Primary vs. Secondary frequency

Primary (主動頻率)

- Force vibration
- Normally with overtones or harmonics
- Frequency varies as driving frequency

Secondary (被動頻率)

- Also known as Fundamental or Natural Frequency
- Induced by forced excitation
- Frequency remains the same with various speed of excitation.

Identification of frequency via spectrum analysis

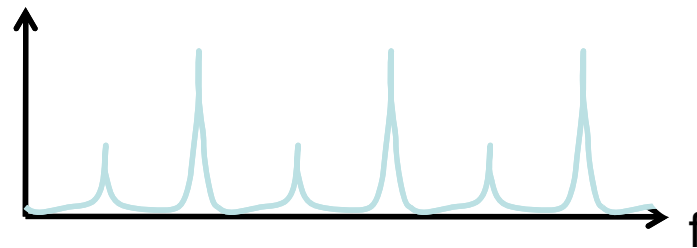

Rpm=10

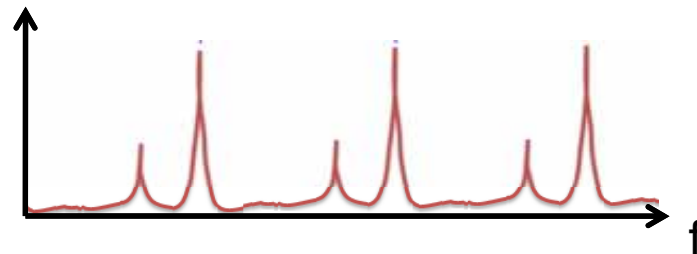

Rpm=15

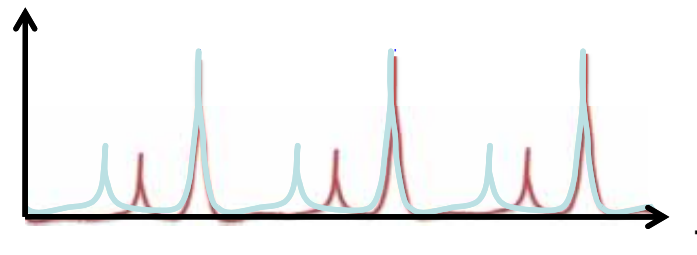

Primary frequencies change with rpm, while secondary frequencies remain the same.

Harmonic and Overtone

- Non-sinusoidal creates harmonics in spectrum domain.
- Overtone generally refers to high frequency peaks which is not exactly multiples of principle frequency. For example, drum beating.
- Both primary and secondary frequencies contain overtones.
- **Primary excitation can only includes harmonics.**

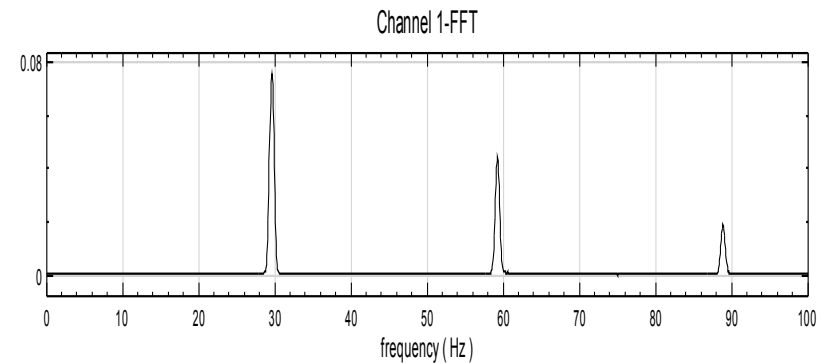
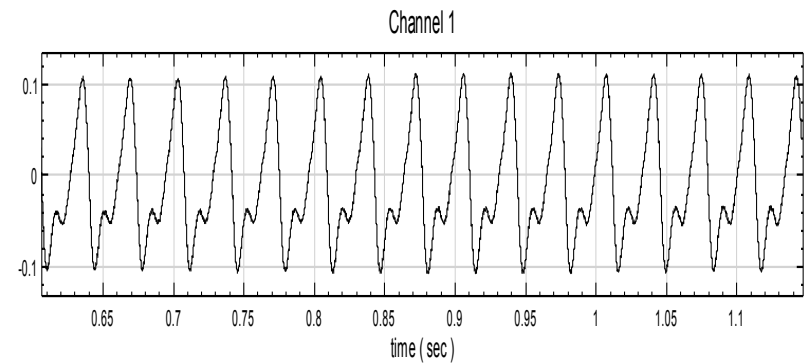

Primary and secondary frequency distinction

Channel 2-Morlet

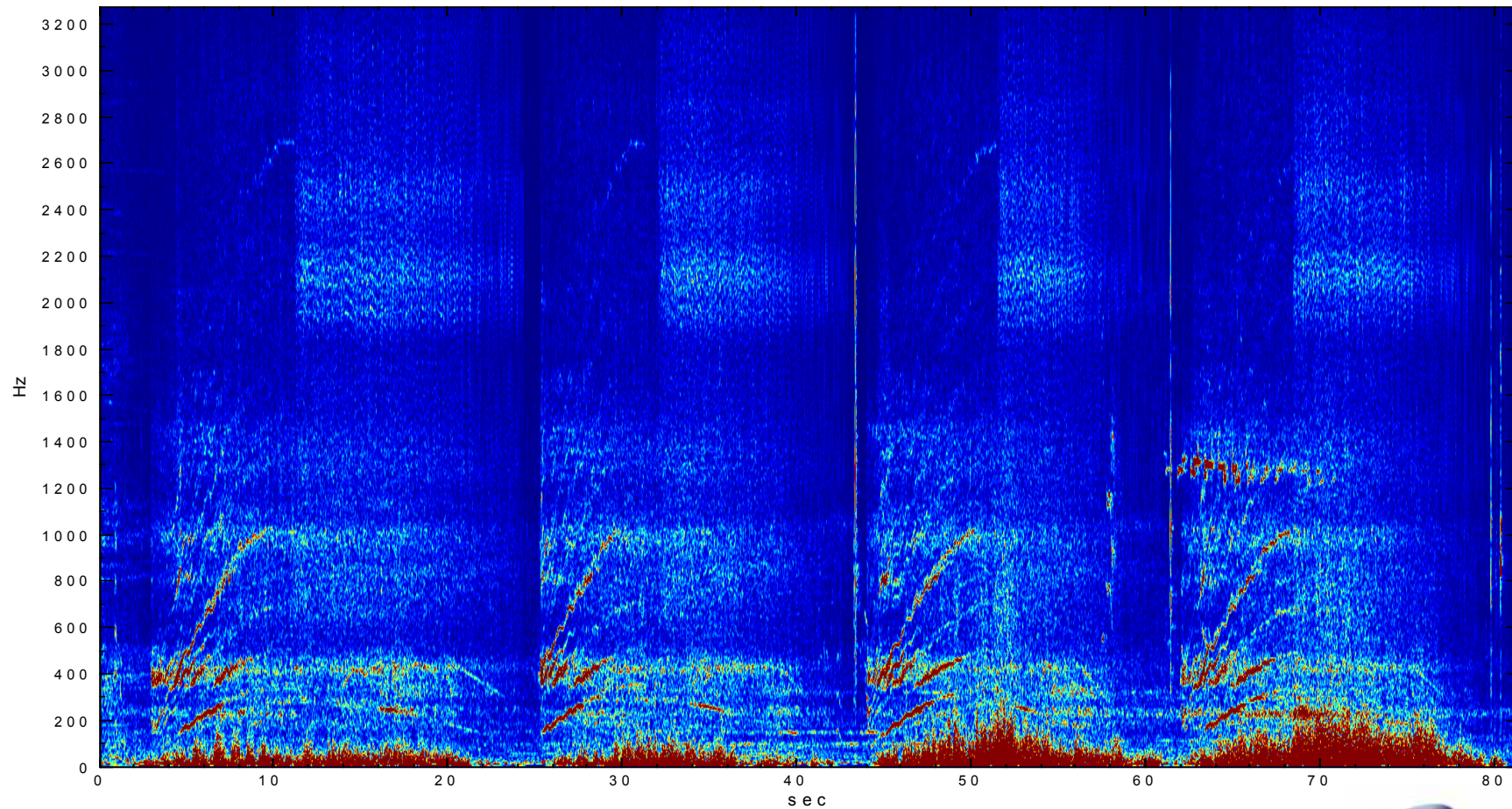

Amplitude modulation (beat wave)

Beat wave

$$\cos(\omega t) + \cos((\omega + \delta\omega)t) \cong 2 \cos(\omega t) \cos\left(\frac{\delta\omega}{2}t\right)$$

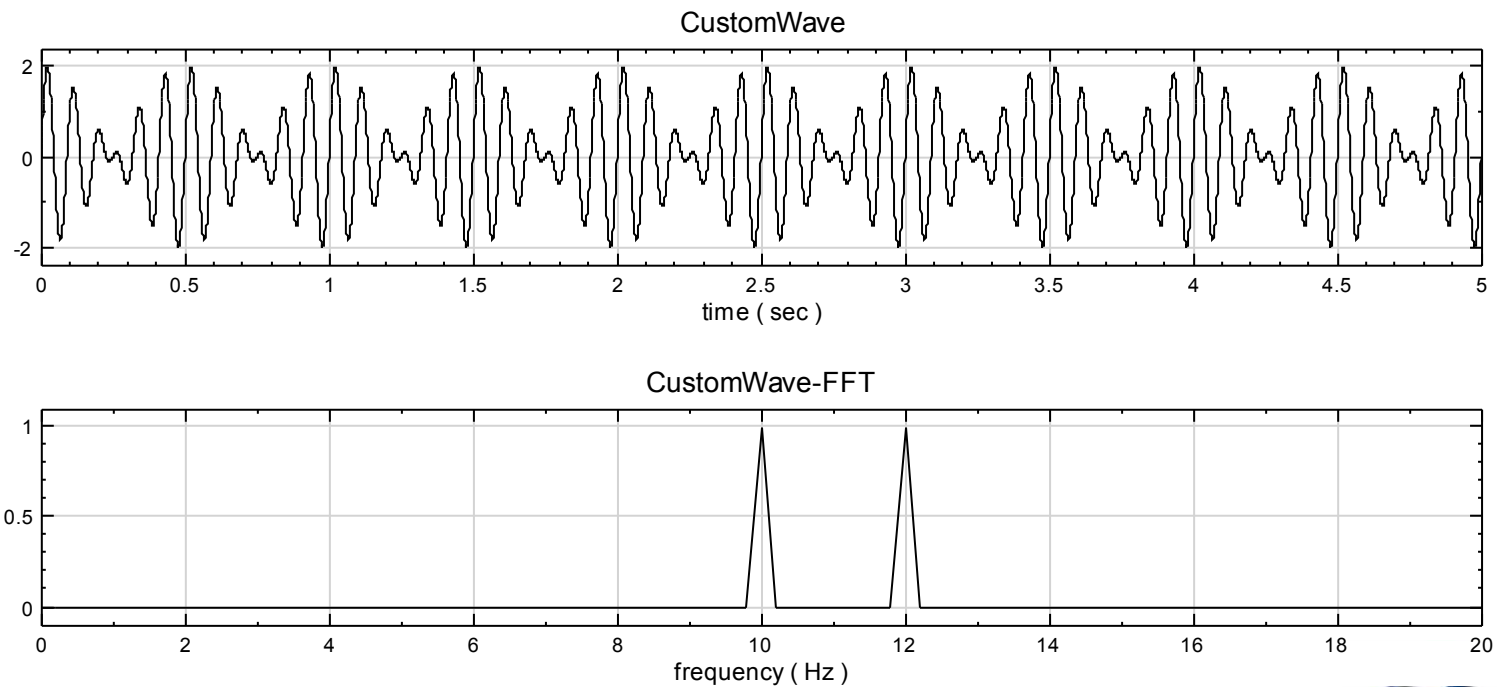

Amplitude modulation

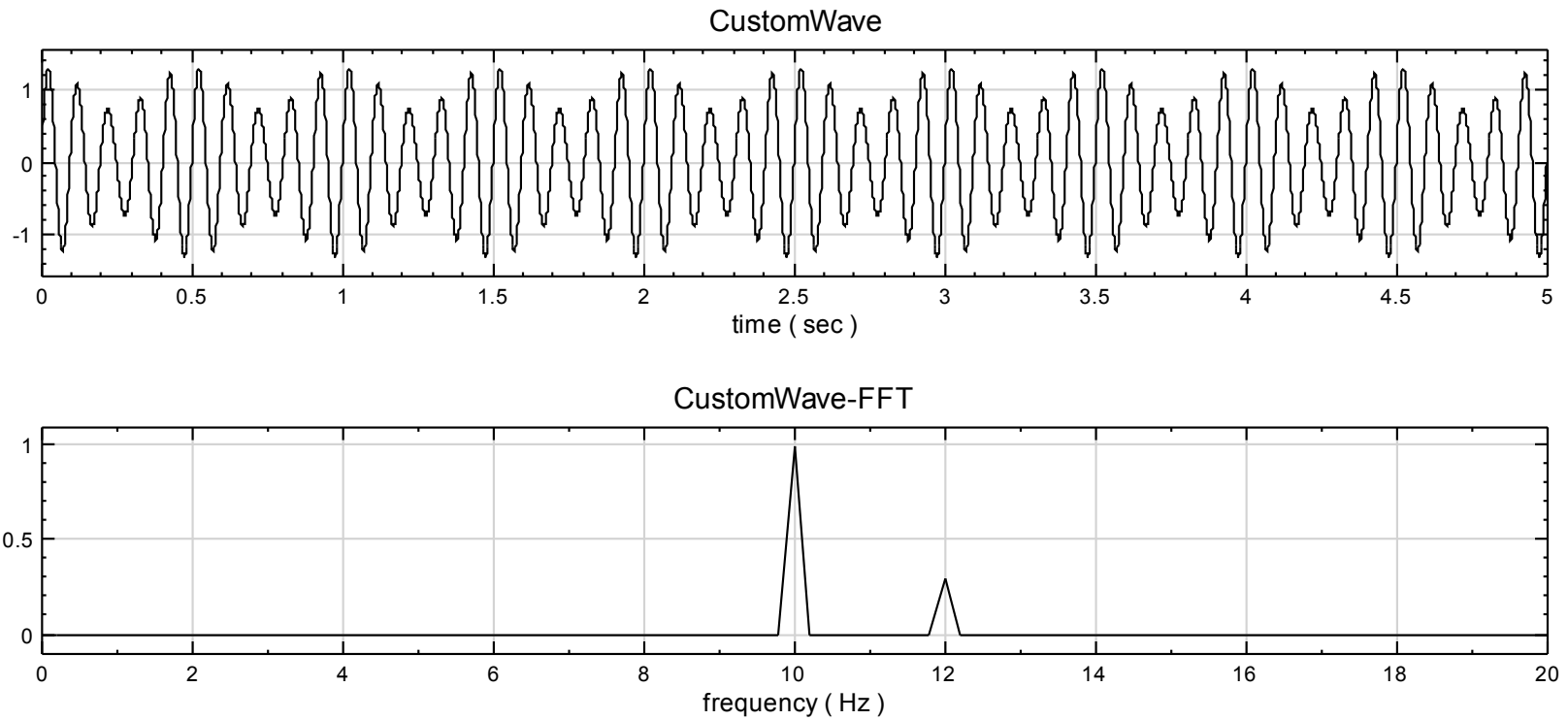

Semi-diurnal tide in ground water

Beat wave occurs twice per month.

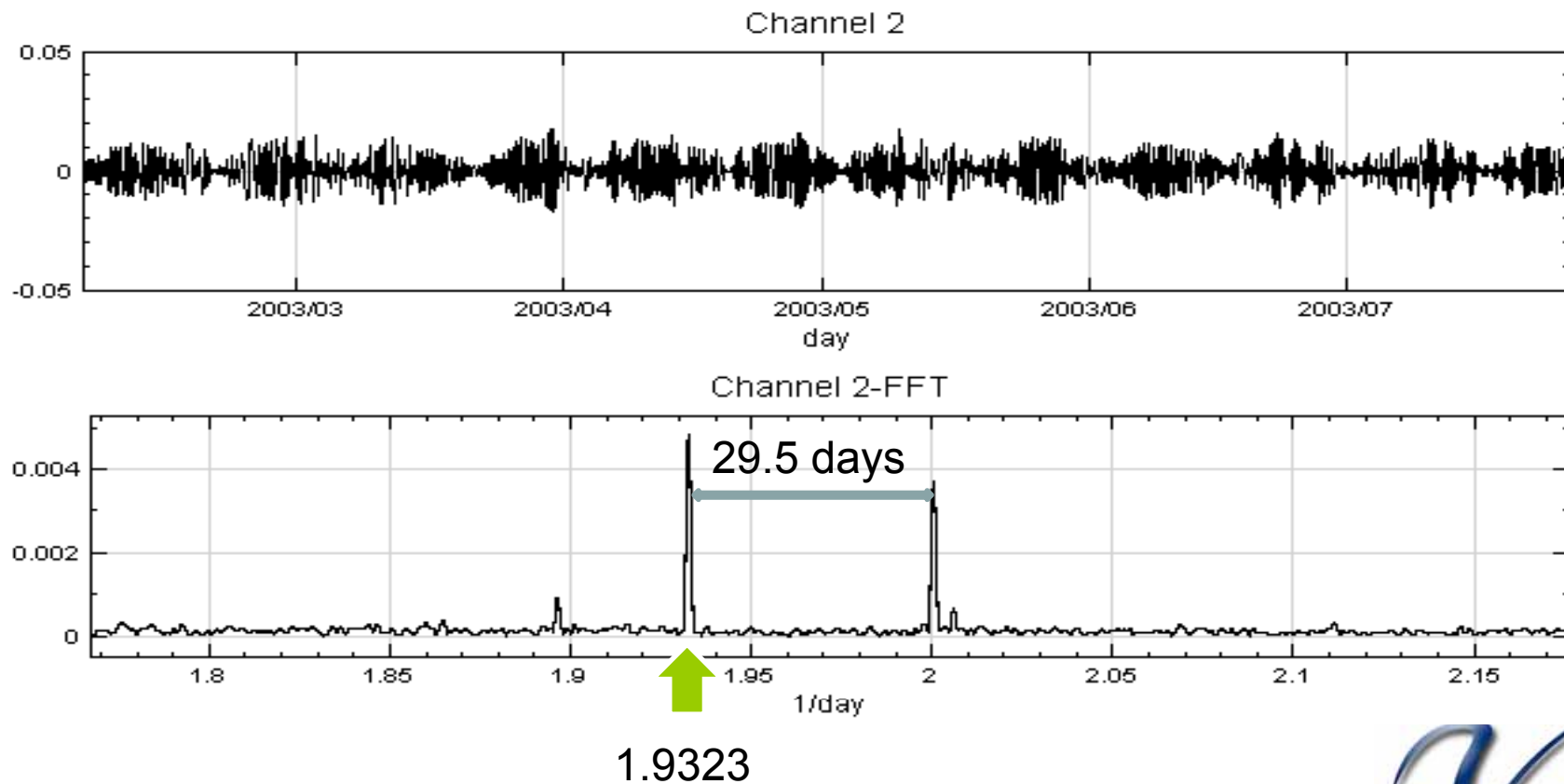

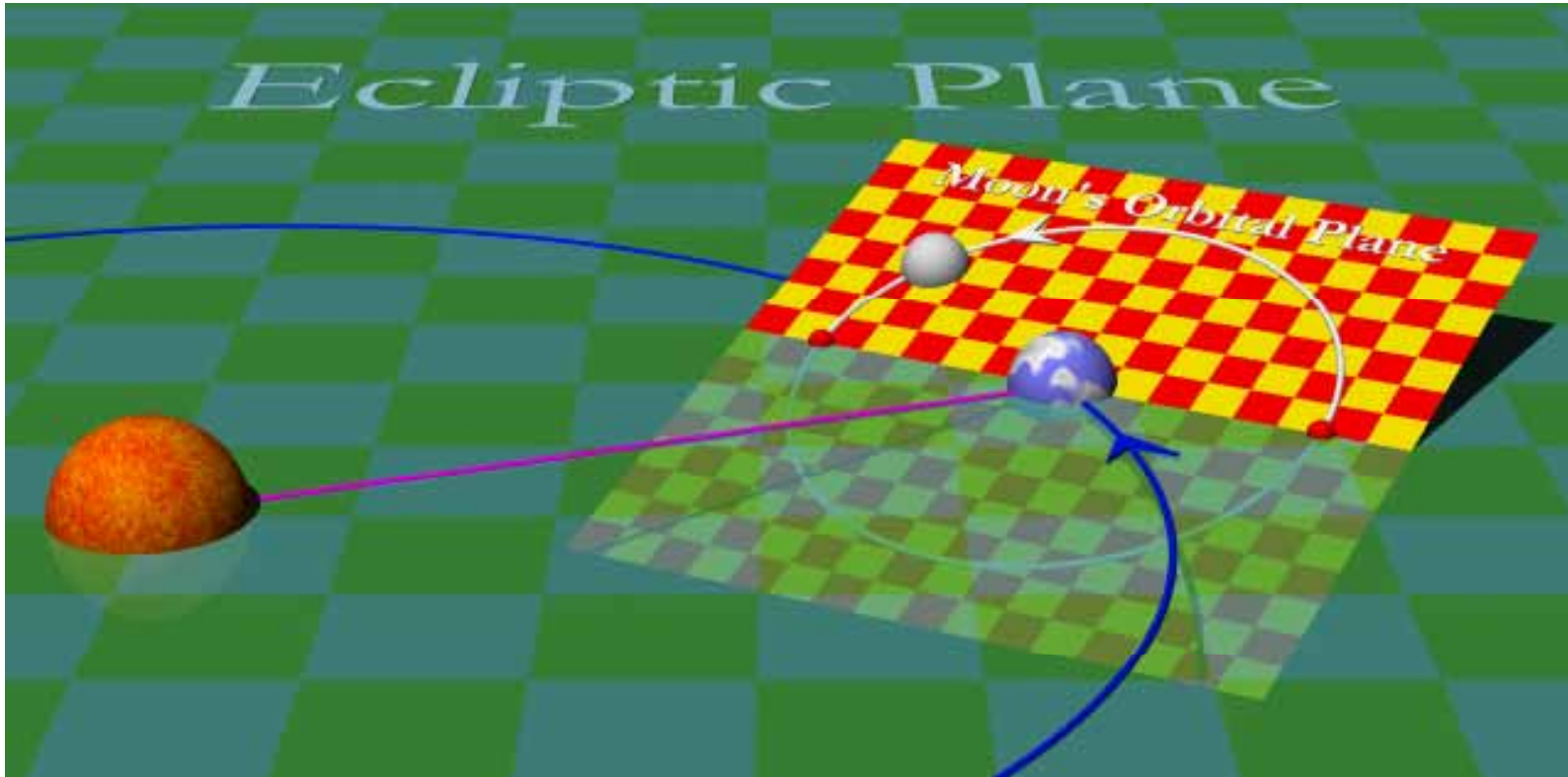

Adapted from: http://www.hermit.org/eclipse/why_cycles.html



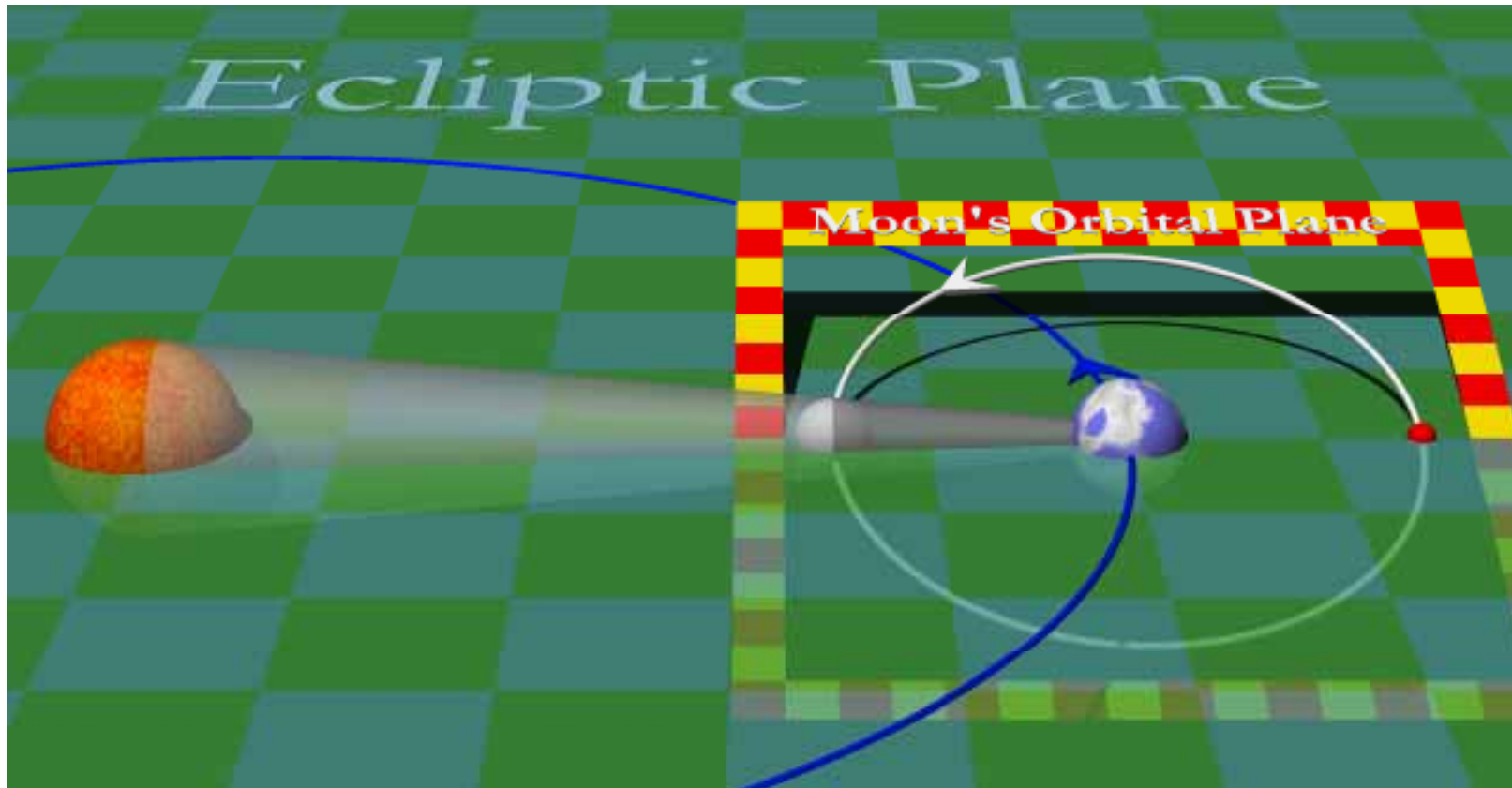

Adapted from: http://www.hermit.org/eclipse/why_cycles.html



Single modulation

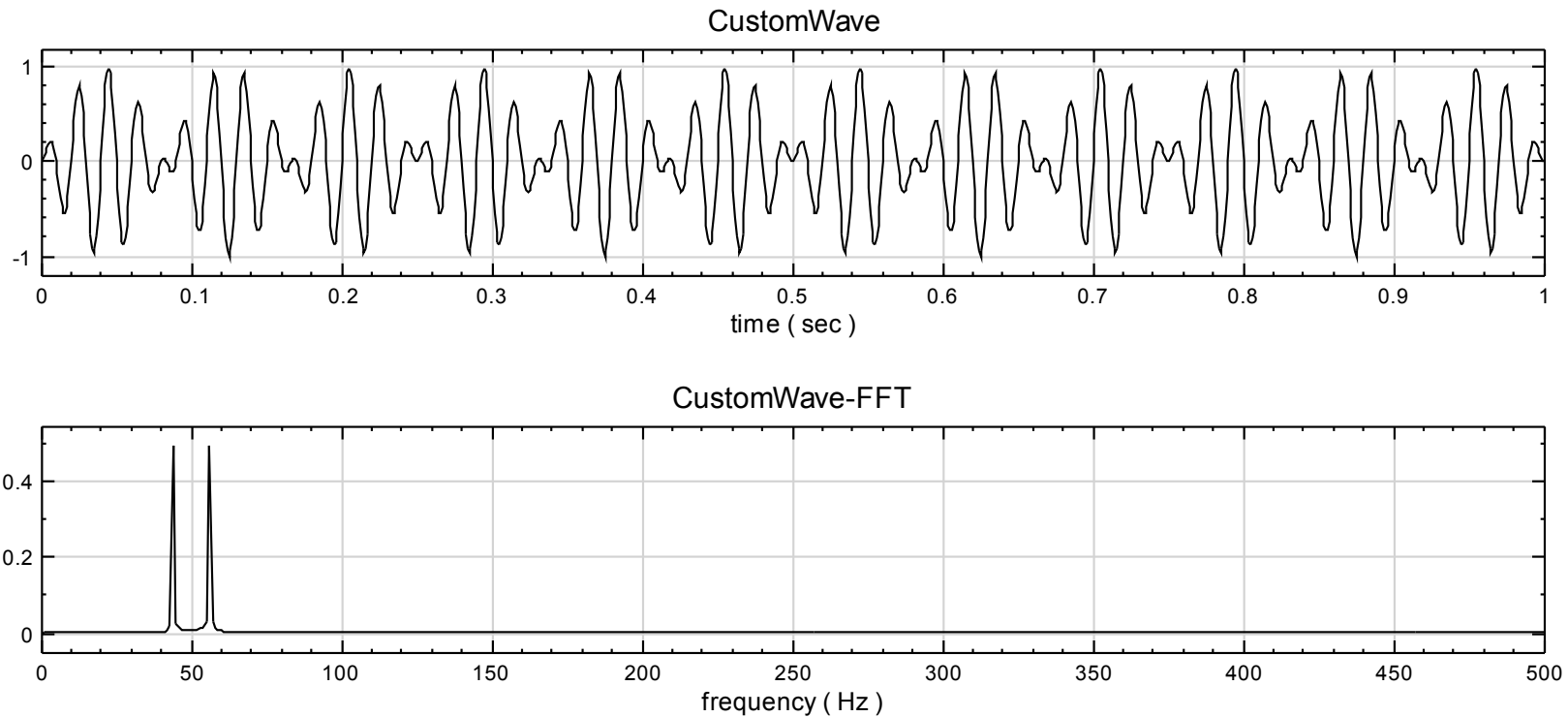

$$\sin(2\pi \cdot 50 \cdot t) \cdot \sin(2\pi \cdot 6 \cdot t)$$

Double modulation

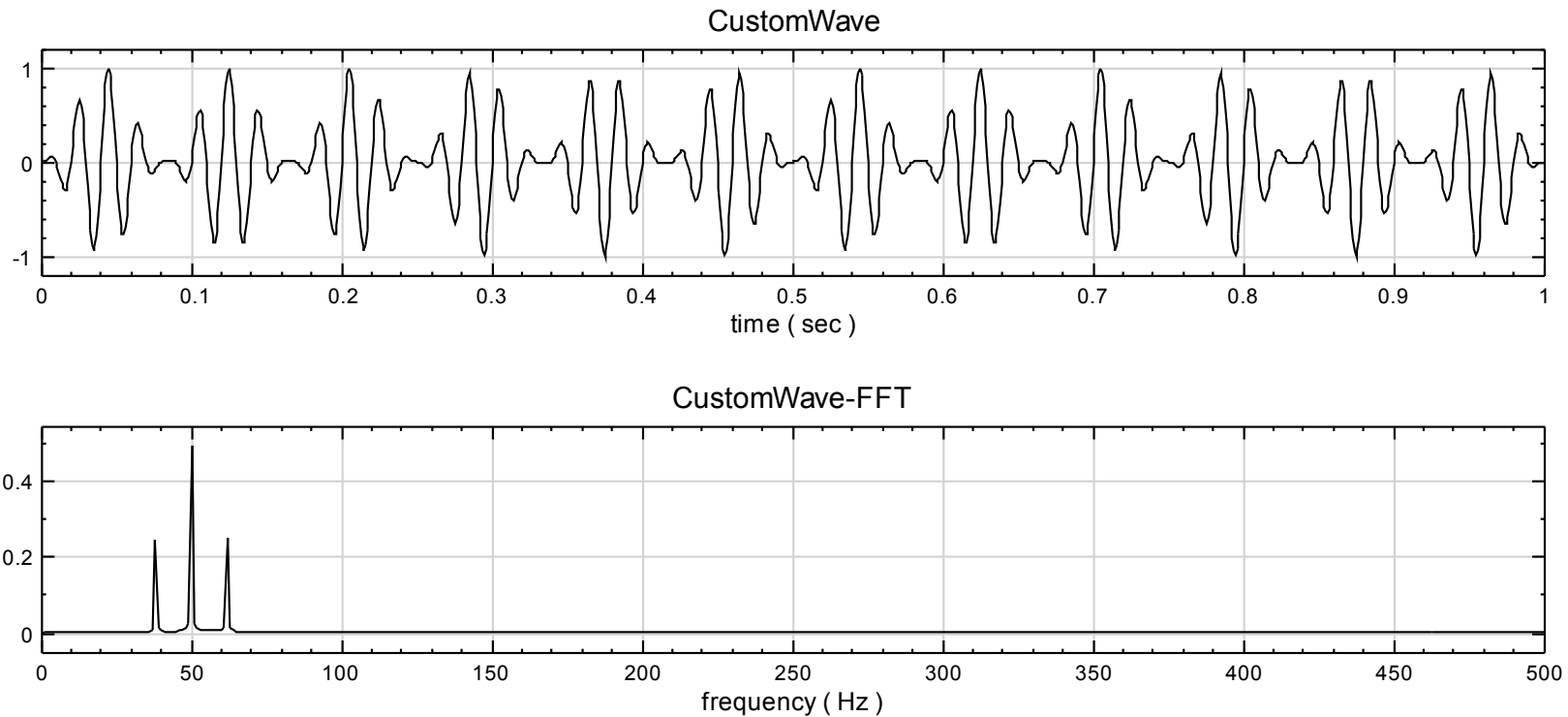

$$\sin(2\pi \cdot 50 \cdot t) \cdot \sin(2\pi \cdot 6 \cdot t) \cdot \sin(2\pi \cdot 6 \cdot t)$$

Single modulation

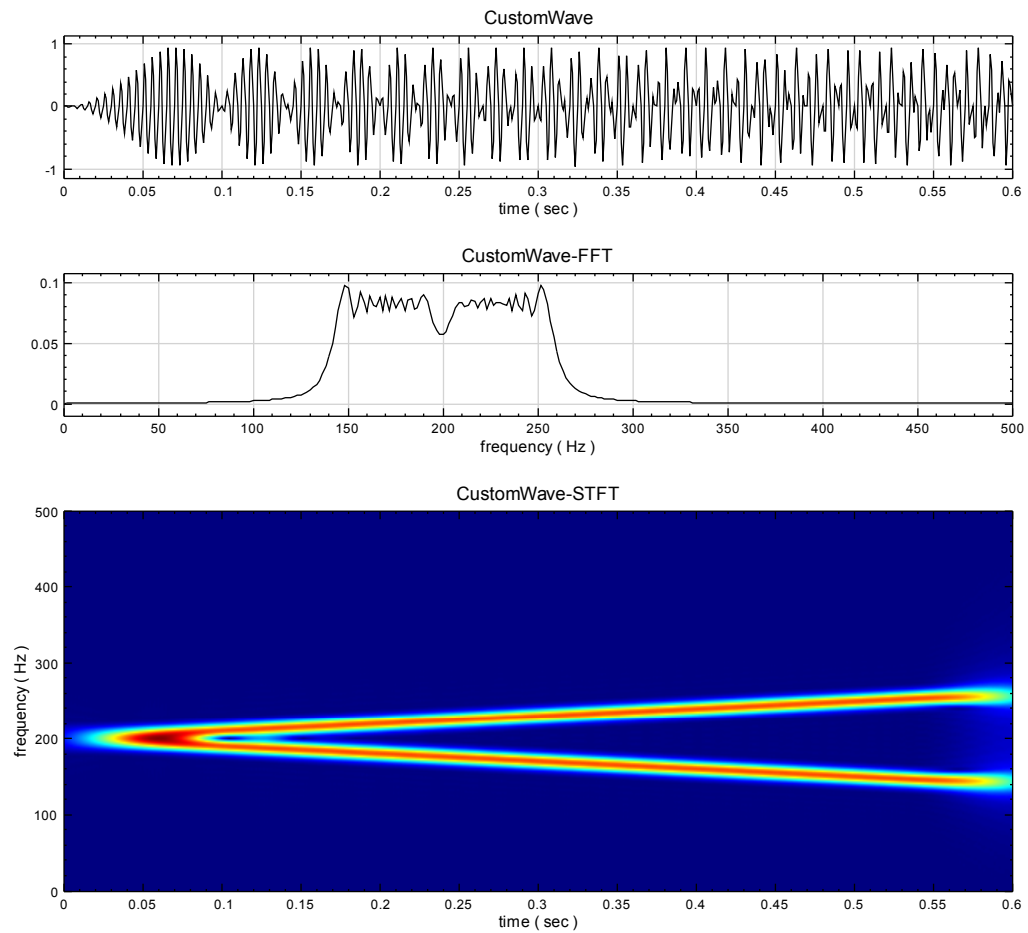

$$\sin(2*\pi*50*t*t)*\sin(2*\pi*200*t)$$

Double modulation

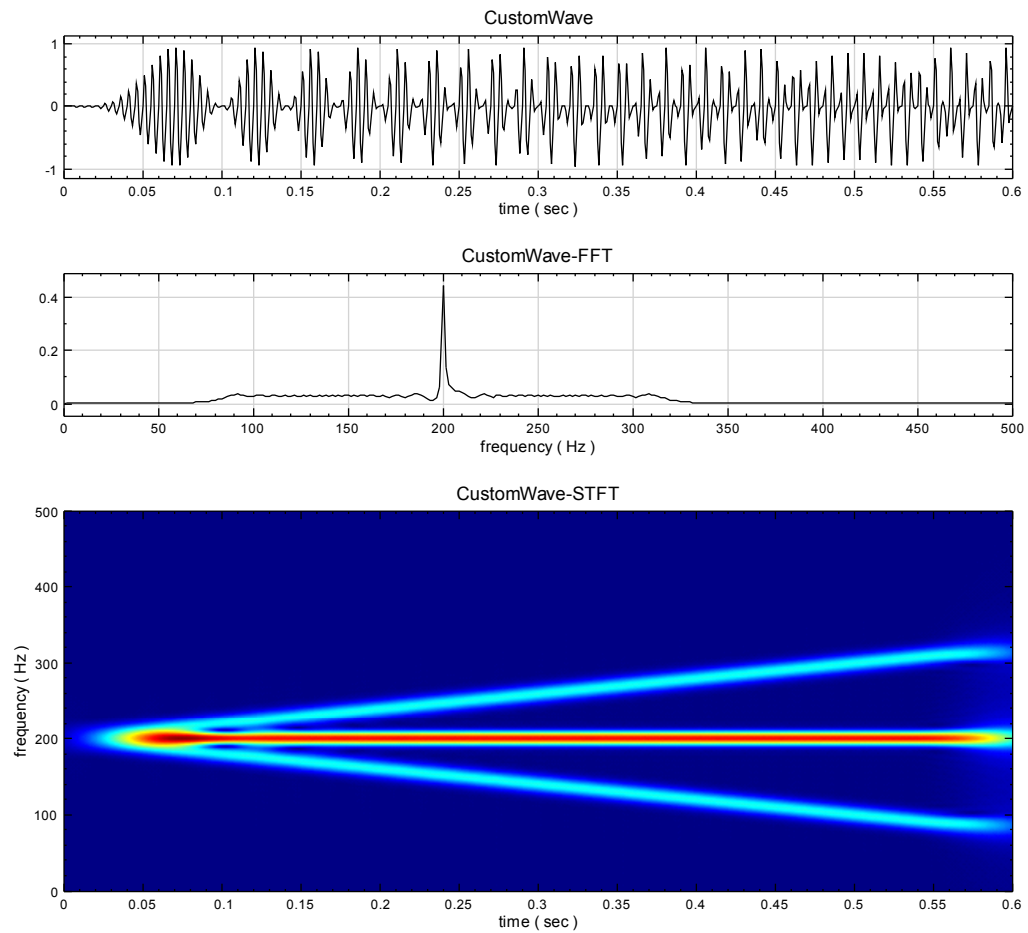

$$\sin(2\pi \cdot 50 \cdot t^2) \cdot \sin(2\pi \cdot 50 \cdot t^2) \cdot \sin(2\pi \cdot 200 \cdot t)$$

Triple modulation

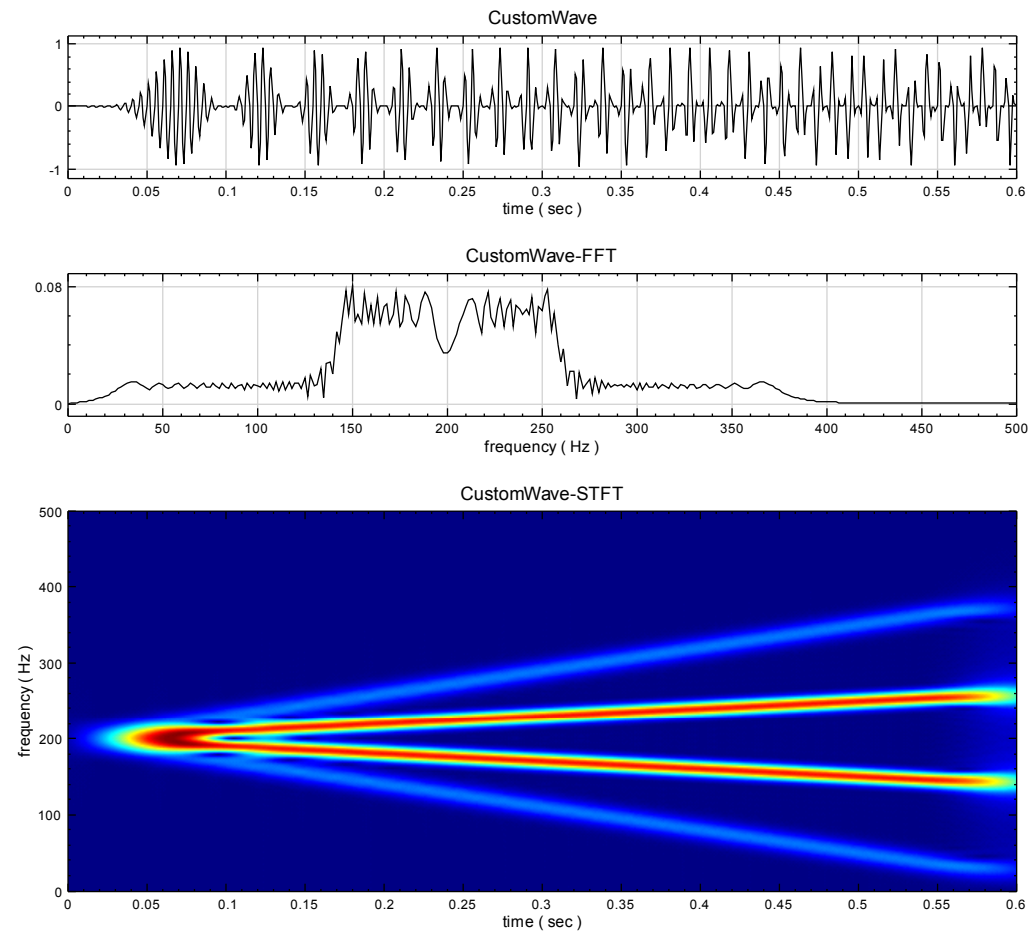

$$\sin(2\pi \cdot 50 \cdot t^2)^3 \cdot \sin(2\pi \cdot 200 \cdot t)$$

AP018-8000



(.wav)

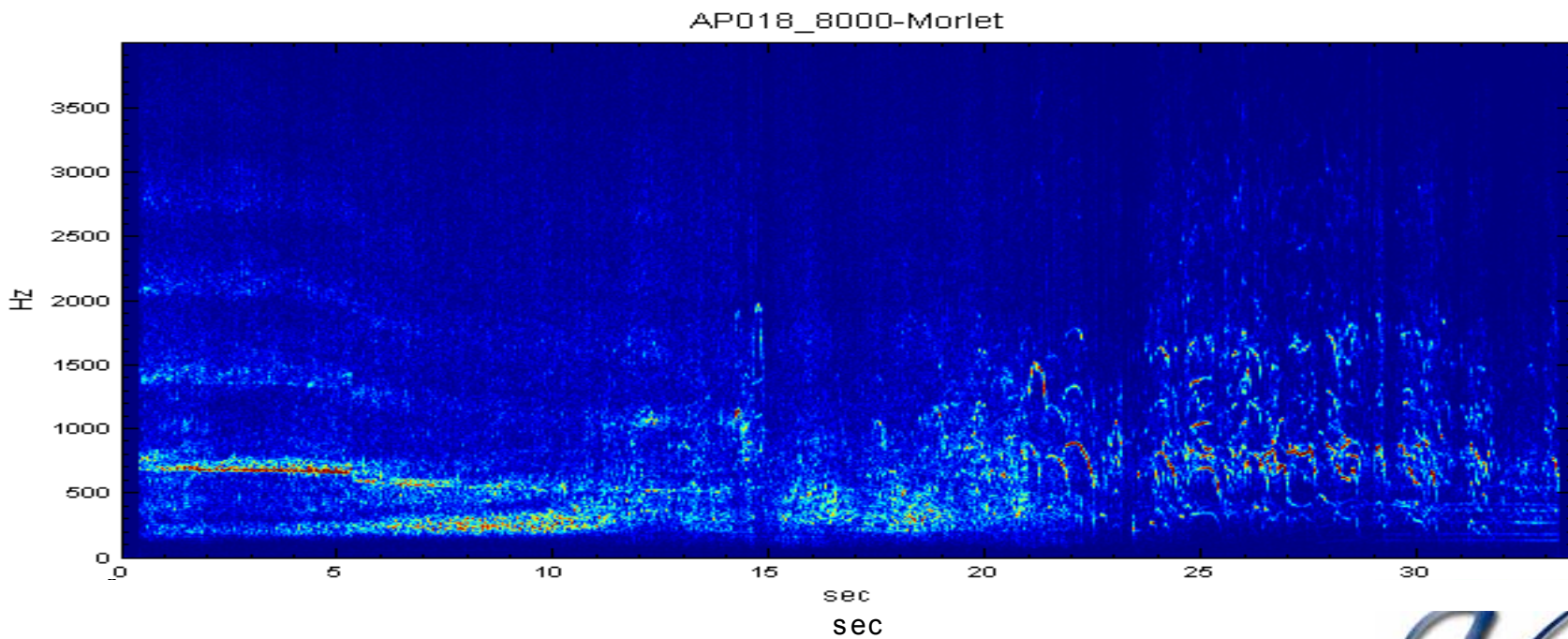
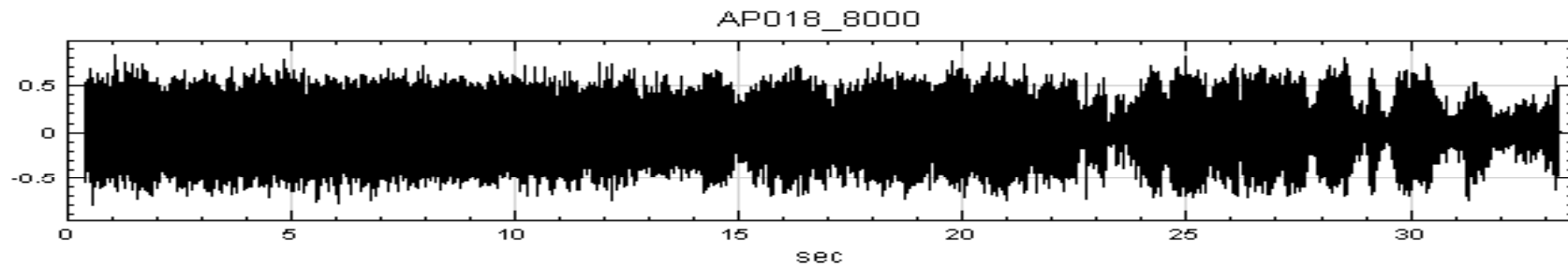

Hilbert-Huang Transform

1. Why is it also called Happy Hilbert Transform?
2. $HHT = EMD + HT$

Empirical Mode Decomposition

原始訊號

tone

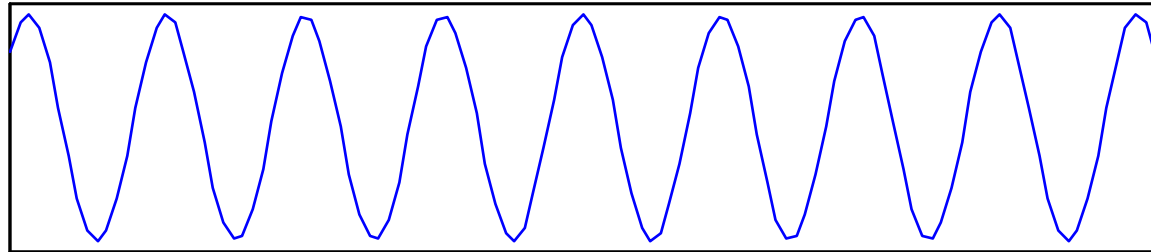

chirp

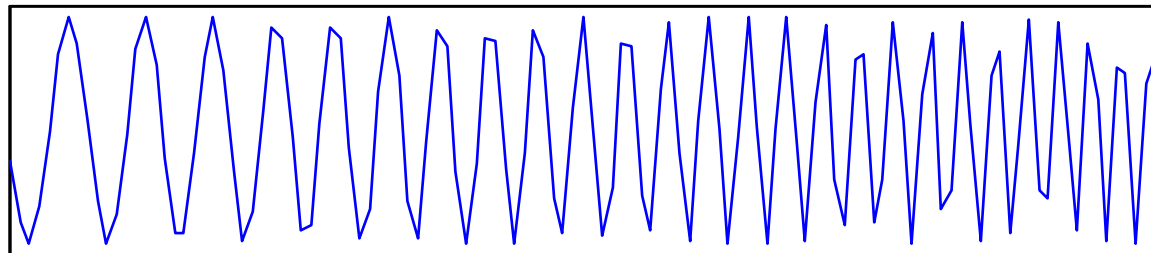

tone + chirp



$X(t)$

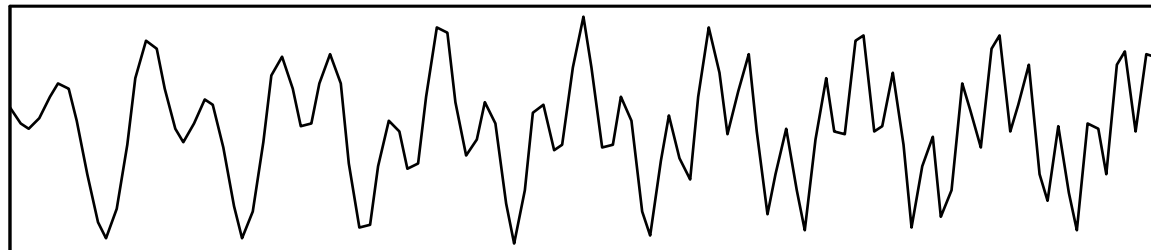

EMD 過程

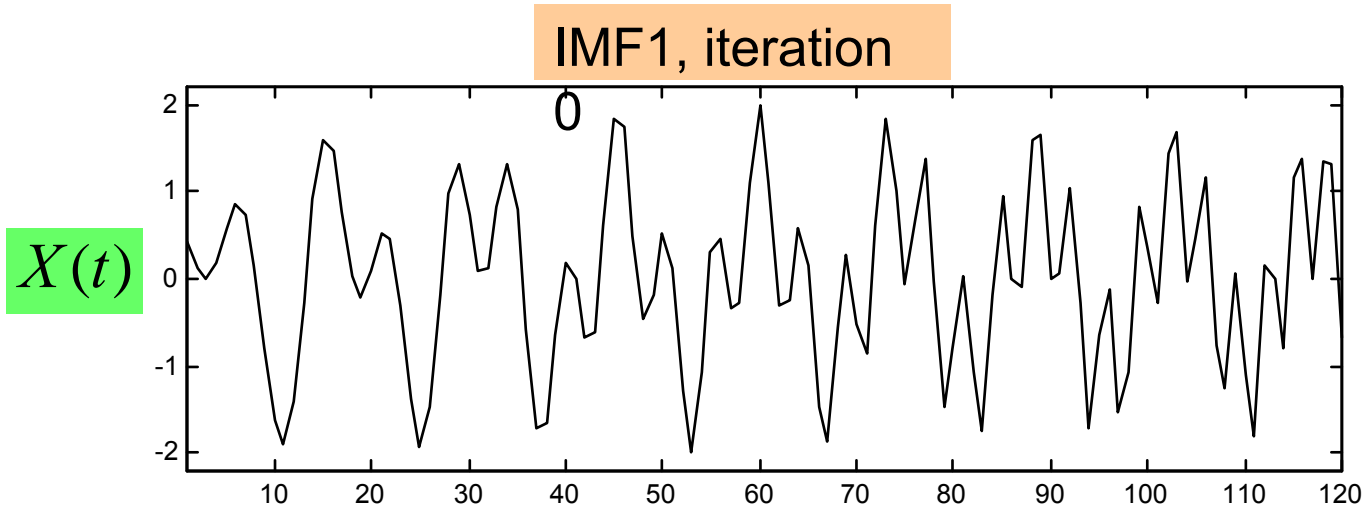

EMD 過程

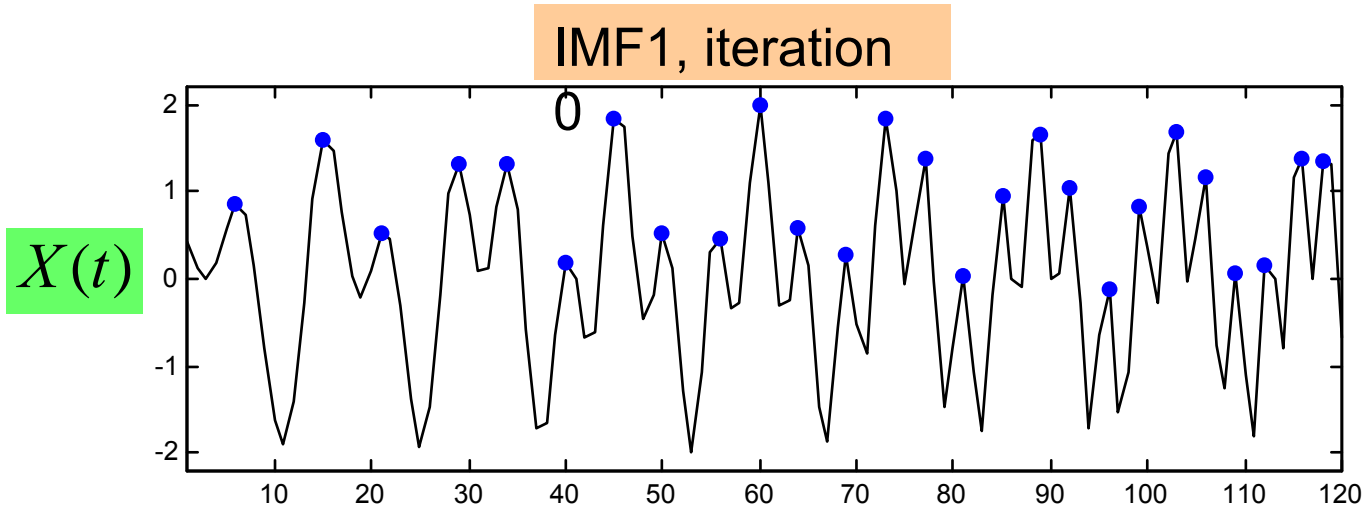

Step1 : 找出局部極大值

EMD 過程

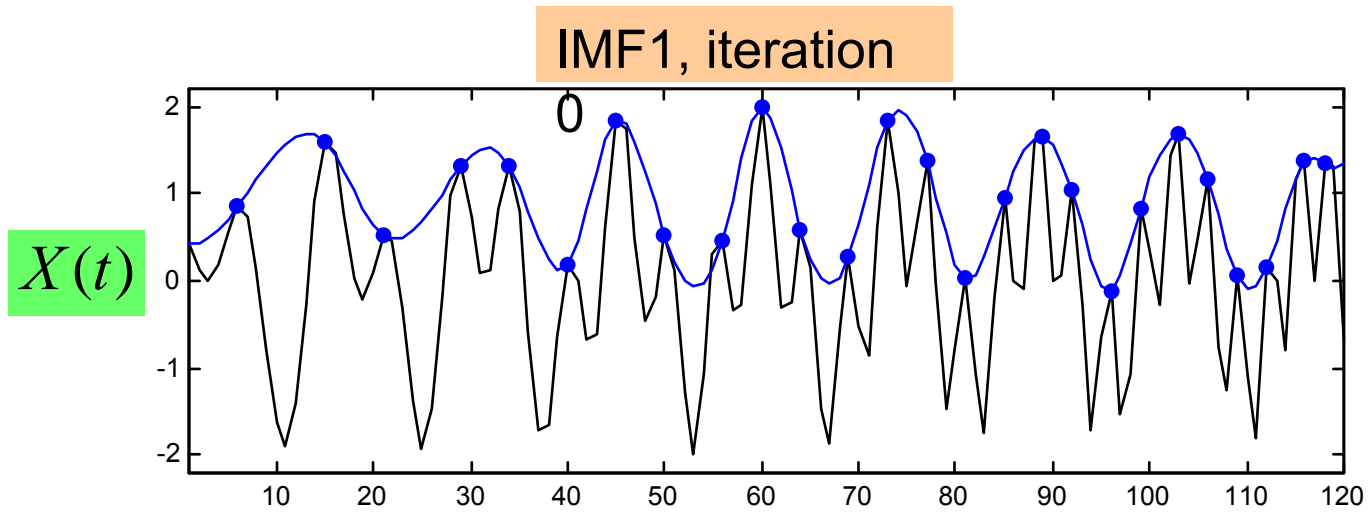

Step2: 找出局部極大值的包絡線

EMD 過程

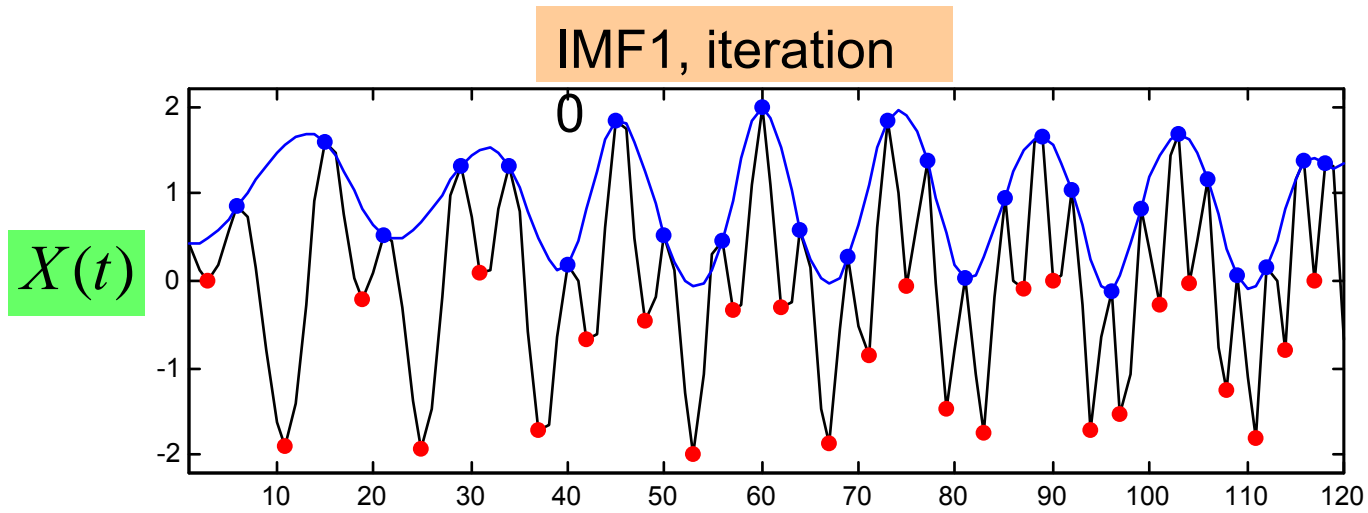

Step3 : 找出局部極小值

EMD 過程

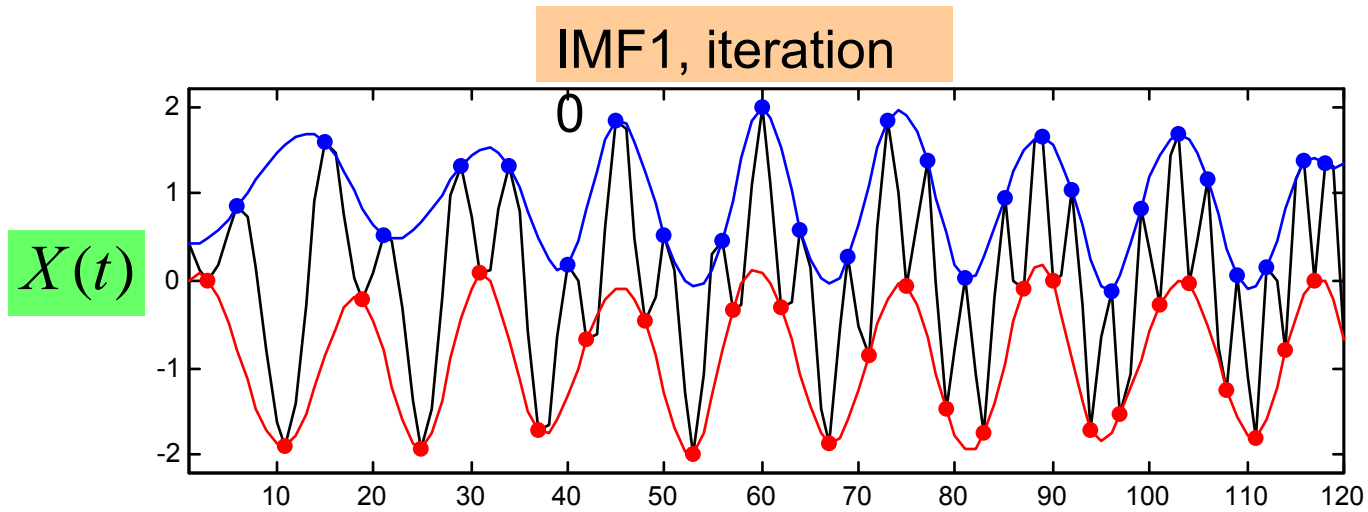

Step4 : 找出局部極小值的包絡線

EMD 過程

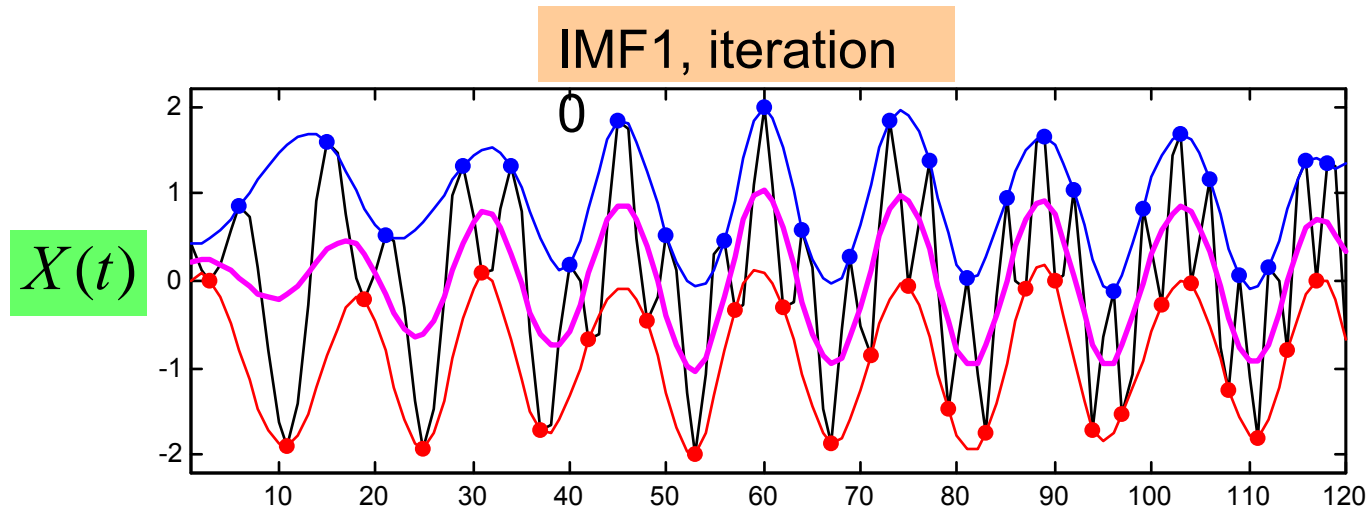

Step5 : 由極大值包絡線與極小值包絡線取得均值包絡線

EMD 過程

IMF1, iteration

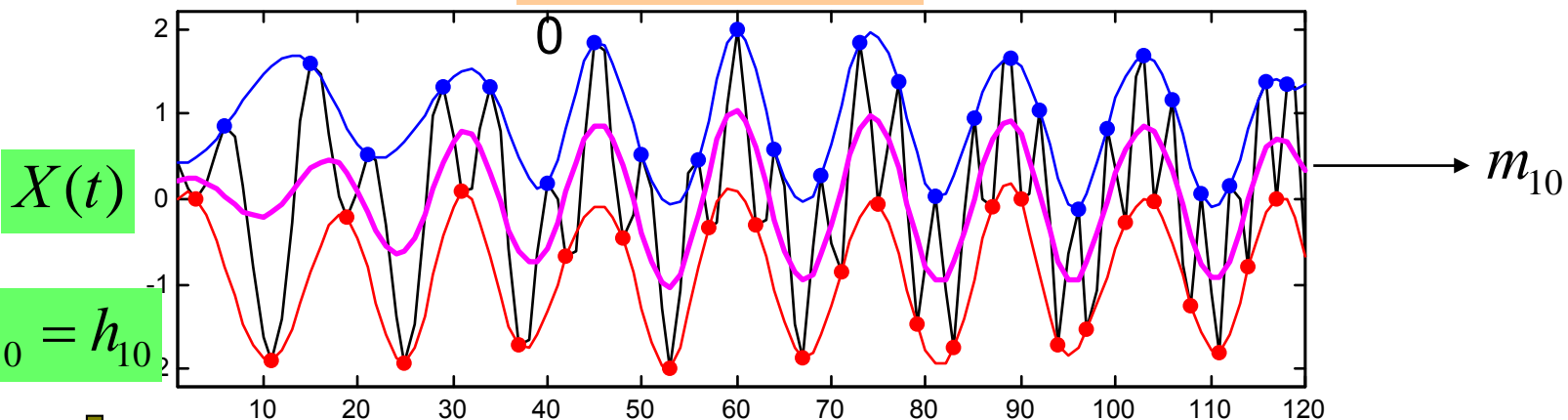

Step6 : 原始訊號與均值包絡線之差即是第一個分量 h_{10}

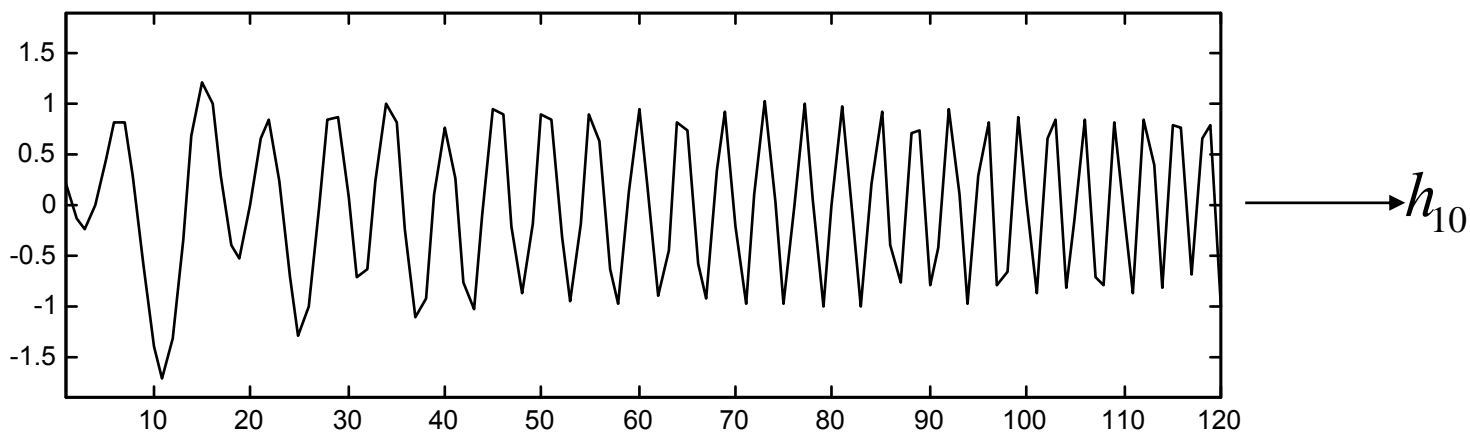

EMD 過程

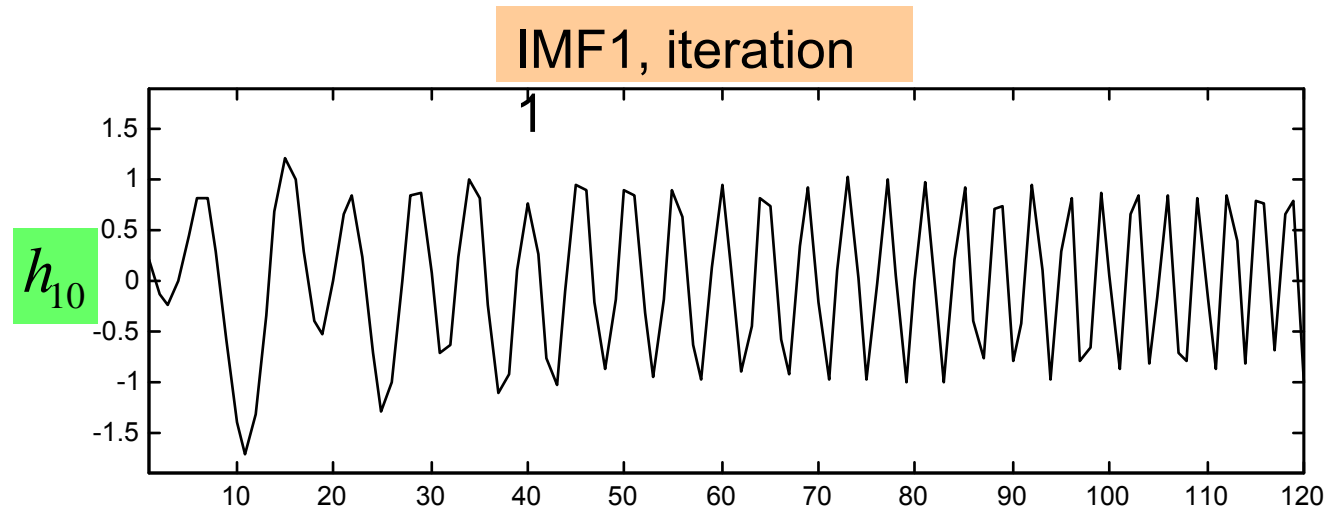

篩檢過程有兩個目的

1. 可消除載波
2. 使得波形更對稱

篩檢過程就必須重複進行很多次方能達成這些結果

EMD 過程

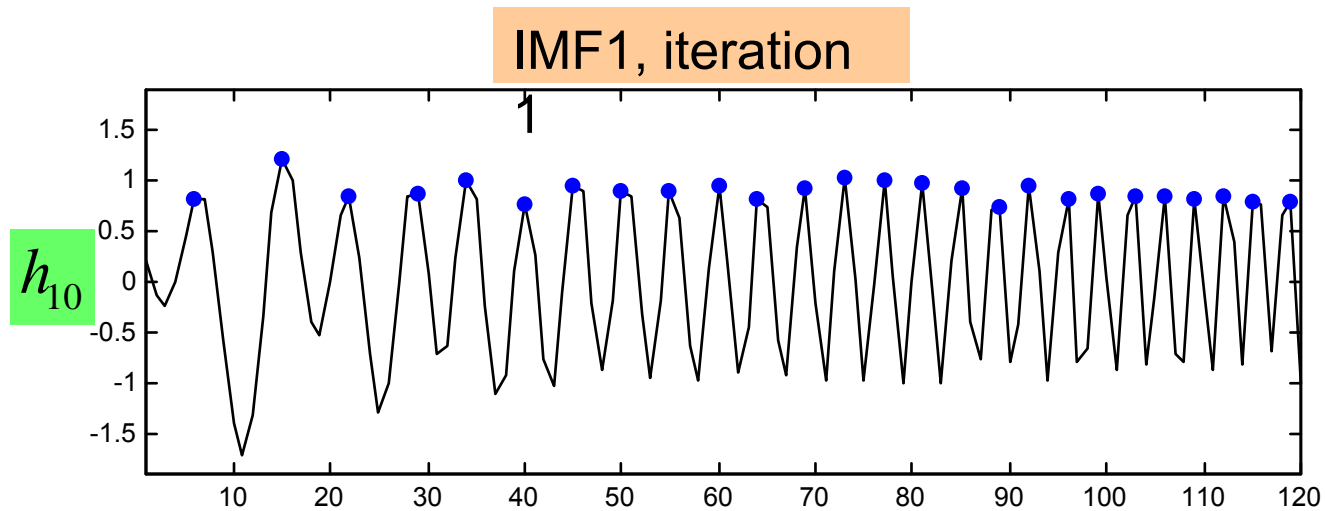

Step1 : 找出局部極大值

EMD 過程

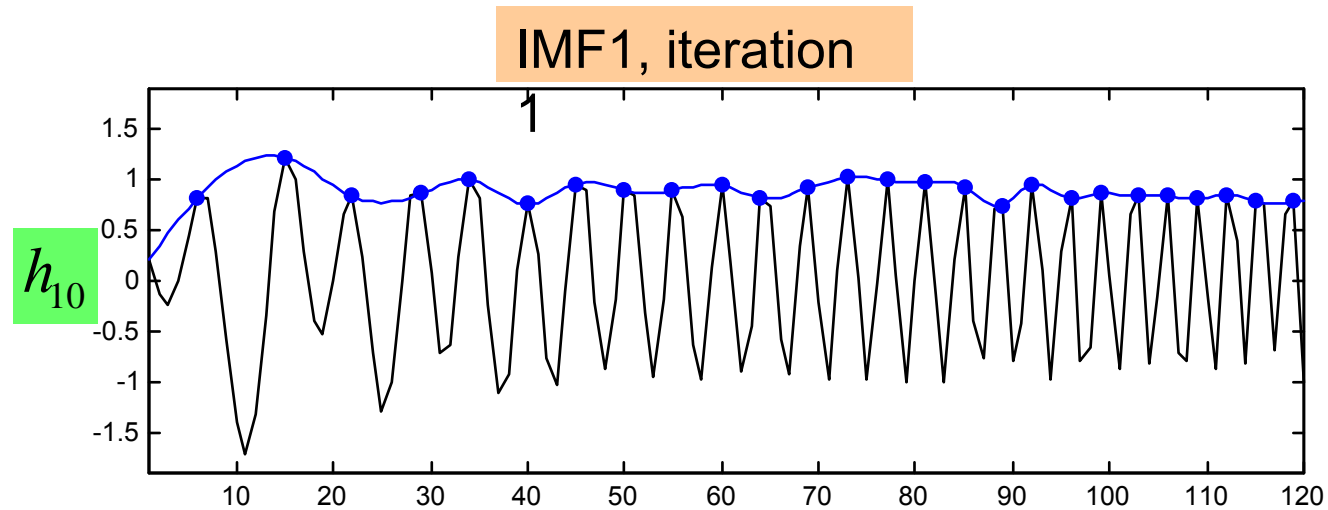

Step2：找出局部極大值的包絡線

EMD 過程

IMF1, iteration

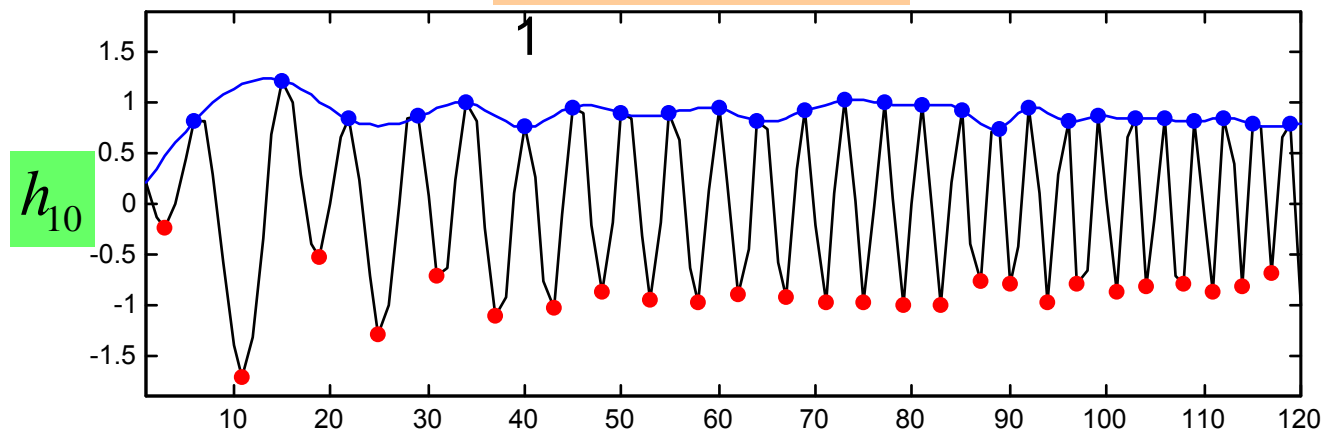

Step3 : 找出局部極小值

EMD 過程

IMF1, iteration

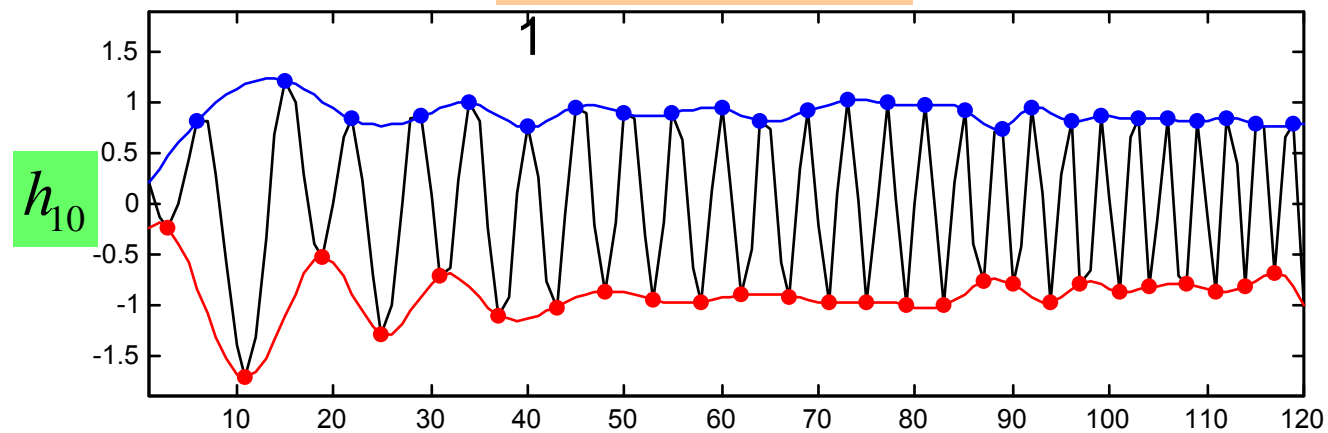

Step4 : 找出局部極小值的包絡線

EMD 過程

IMF1, iteration

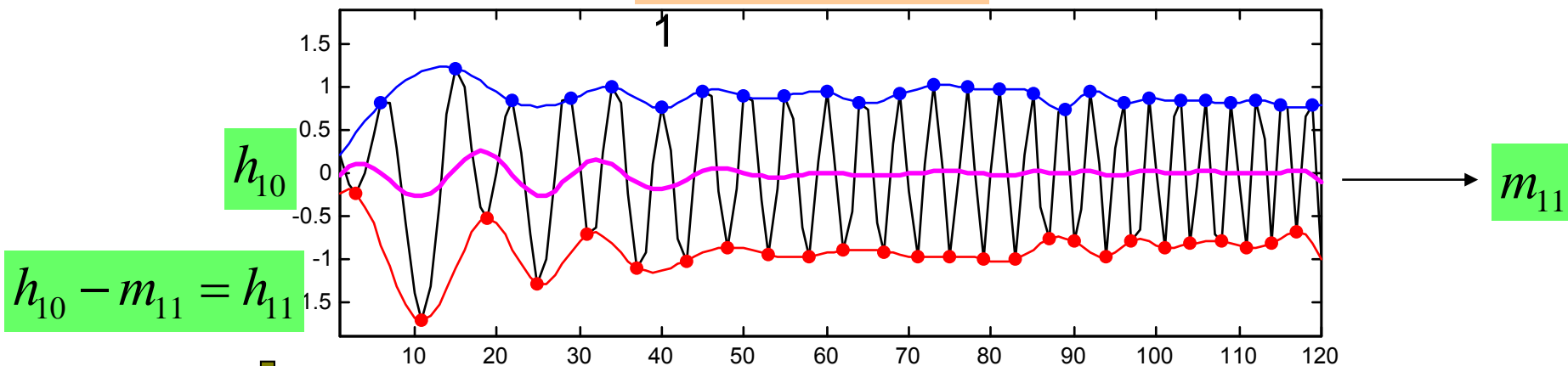

$h_{10} - m_{11} = h_{11}$

m_{11}



residue

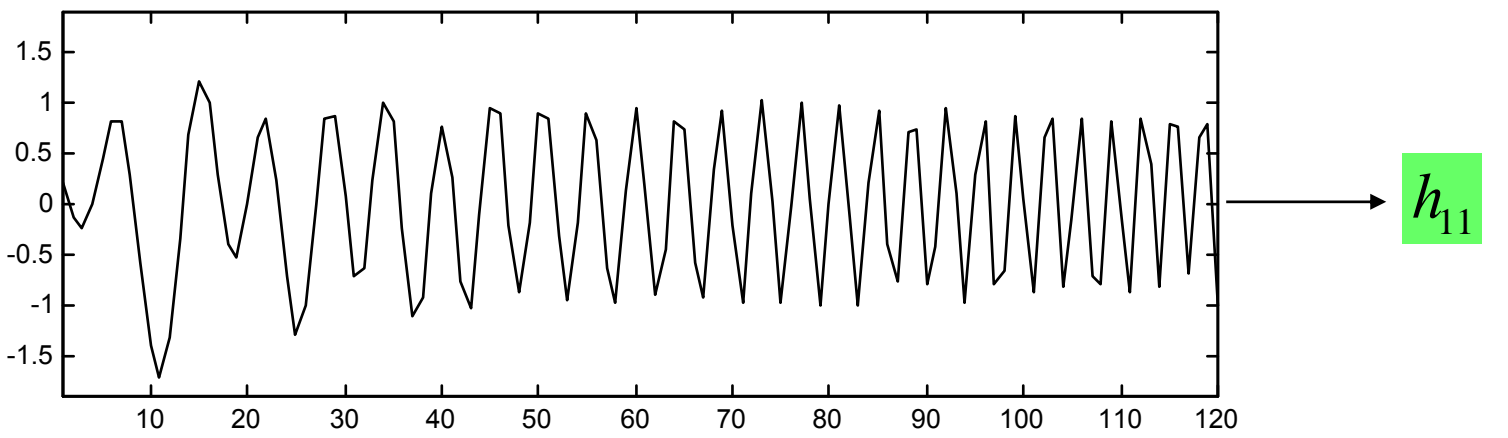

h_{11}

EMD 過程

IMF1, iteration

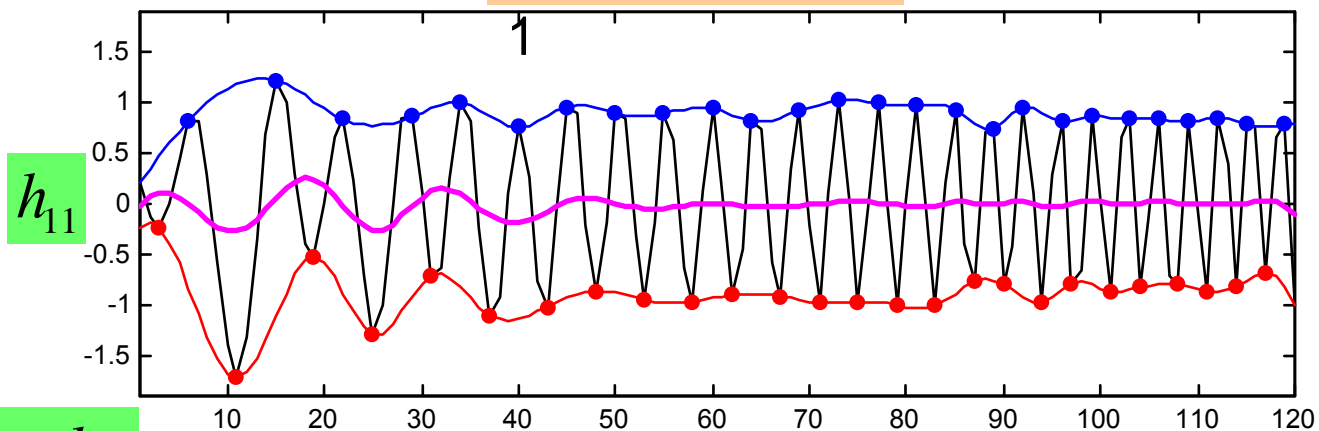

$$h_{10} - m_{11} = h_{11}$$

residue

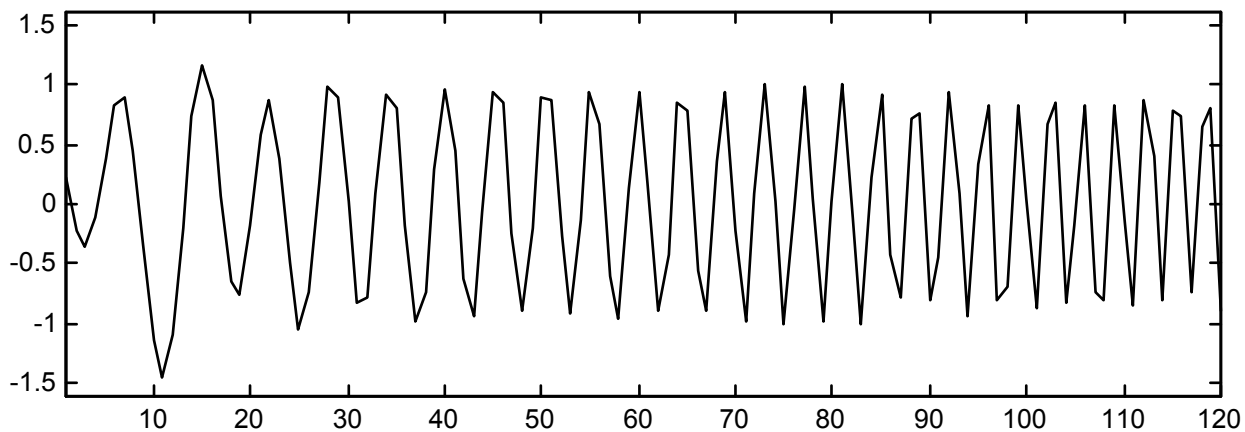

EMD 過程

IMF1, iteration

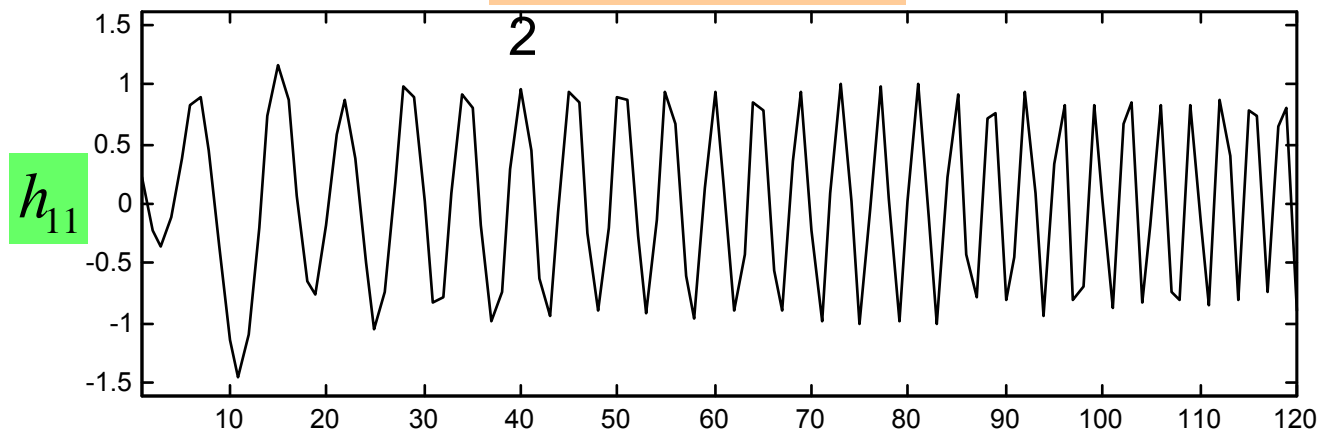

residue

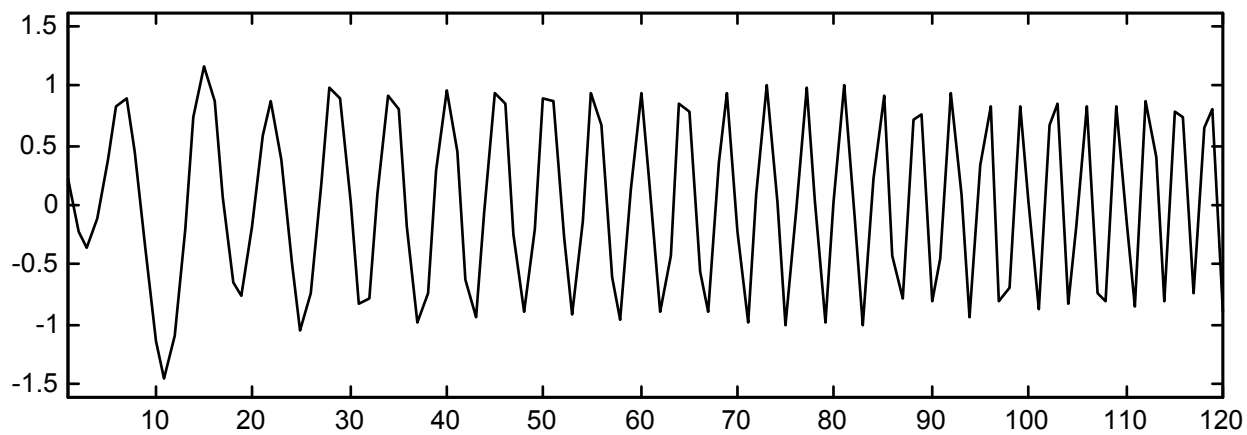

EMD 過程

IMF1, iteration

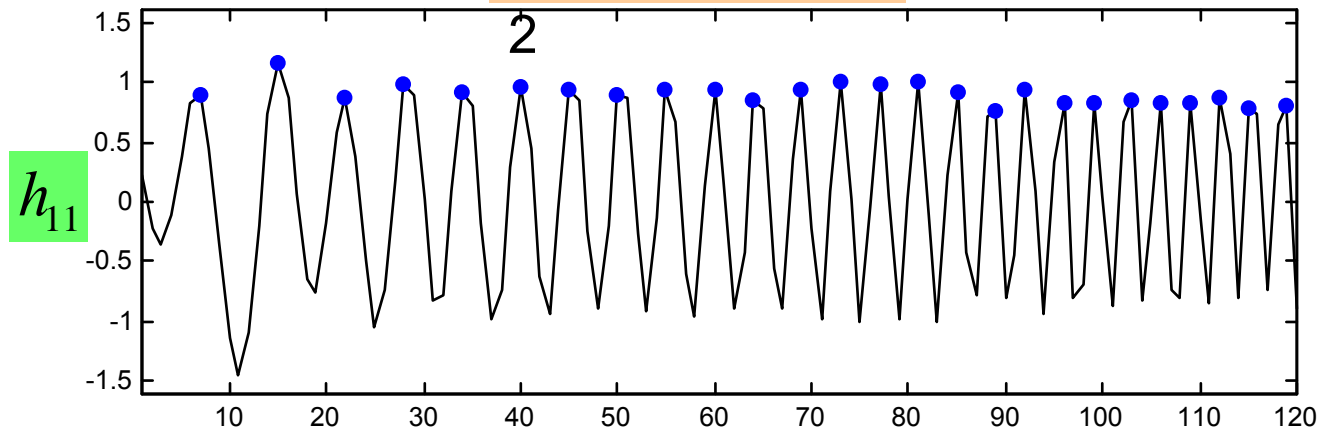

residue

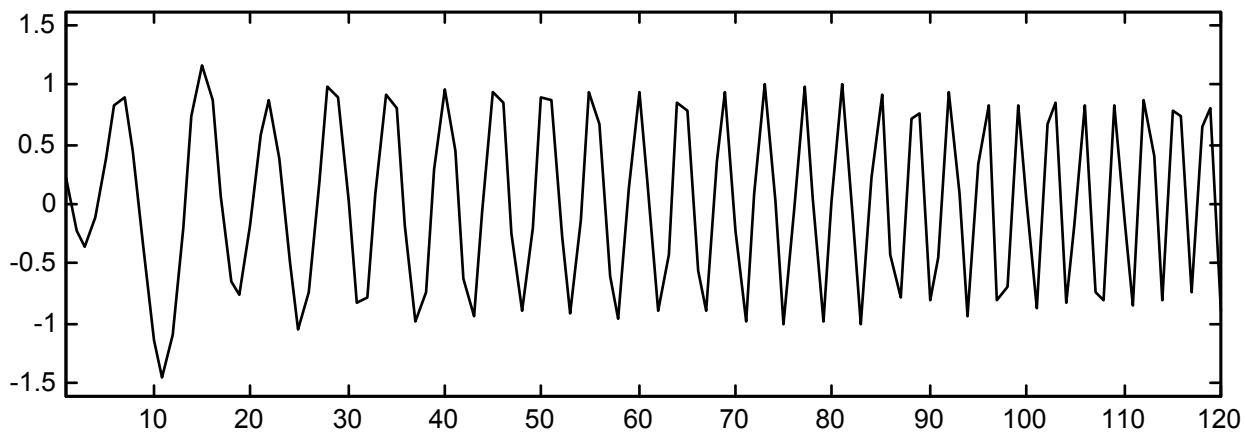

EMD 過程

IMF1, iteration

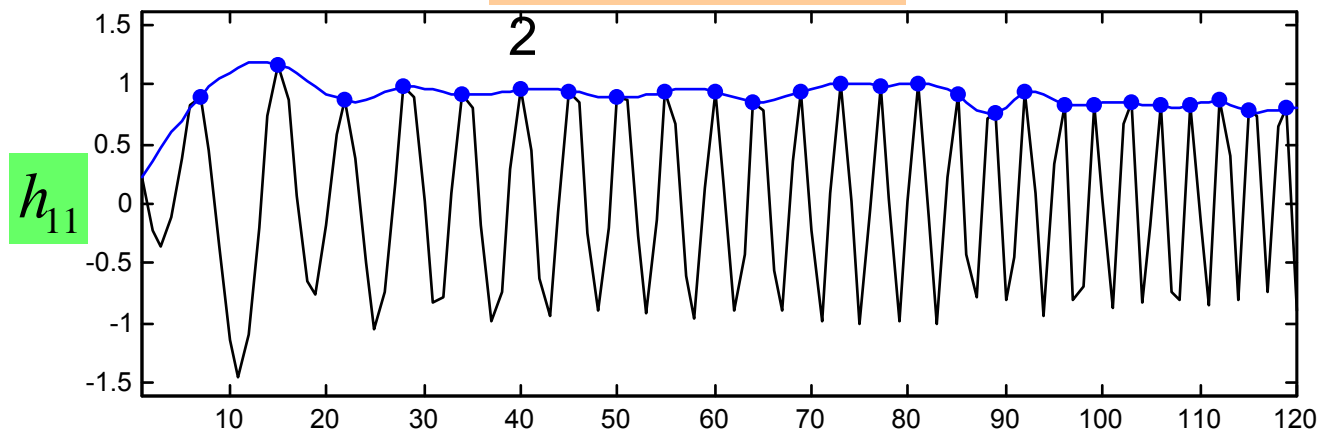

residue

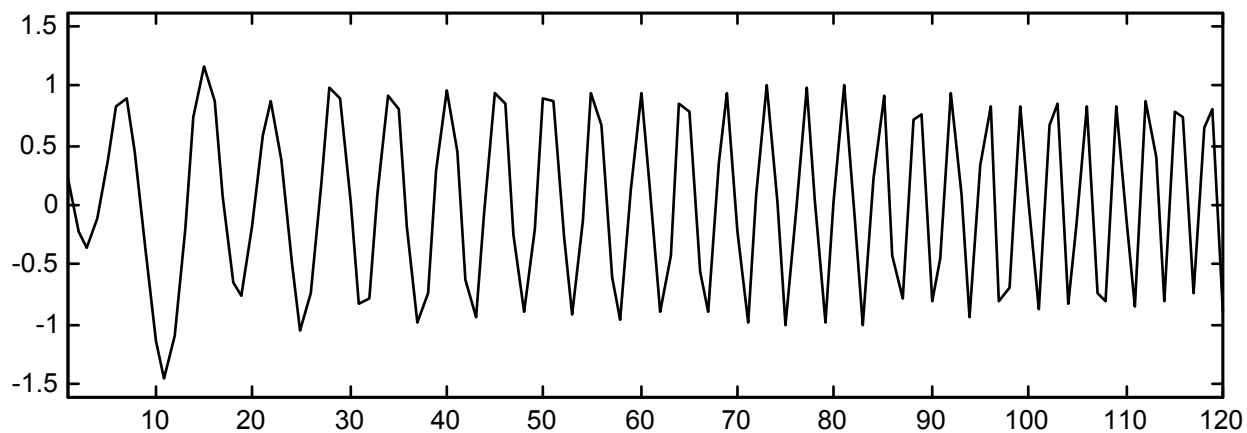

EMD 過程

IMF1, iteration

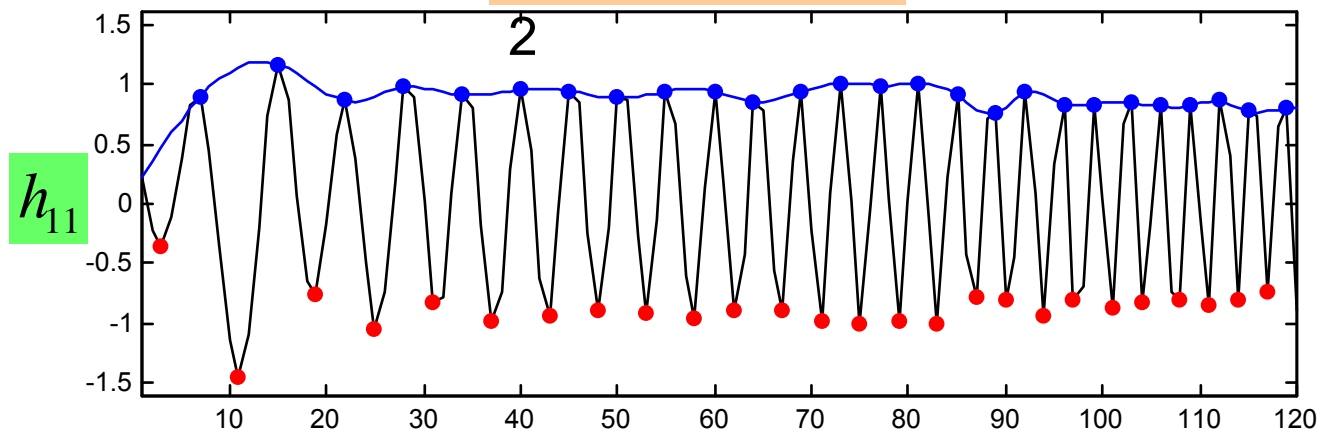

residue

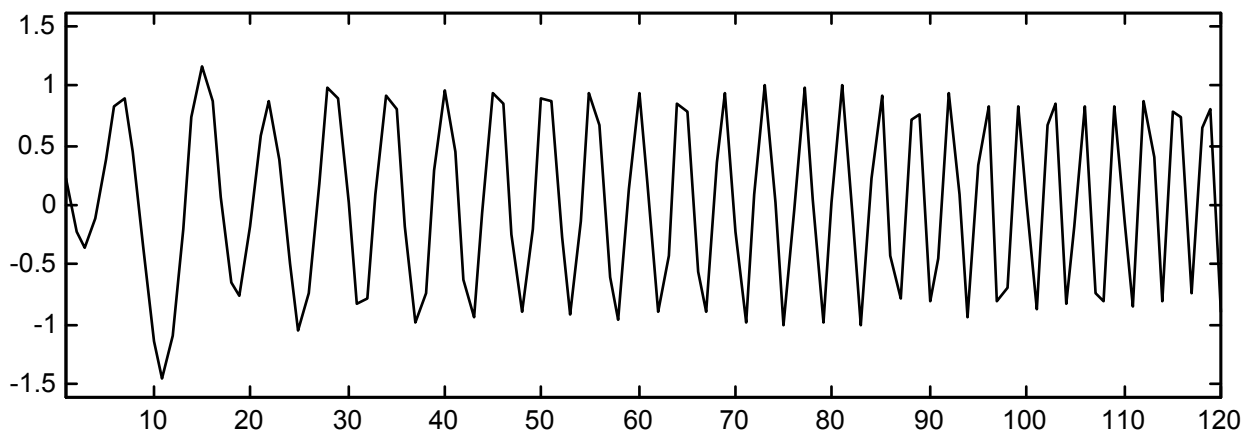

EMD 過程

IMF1, iteration

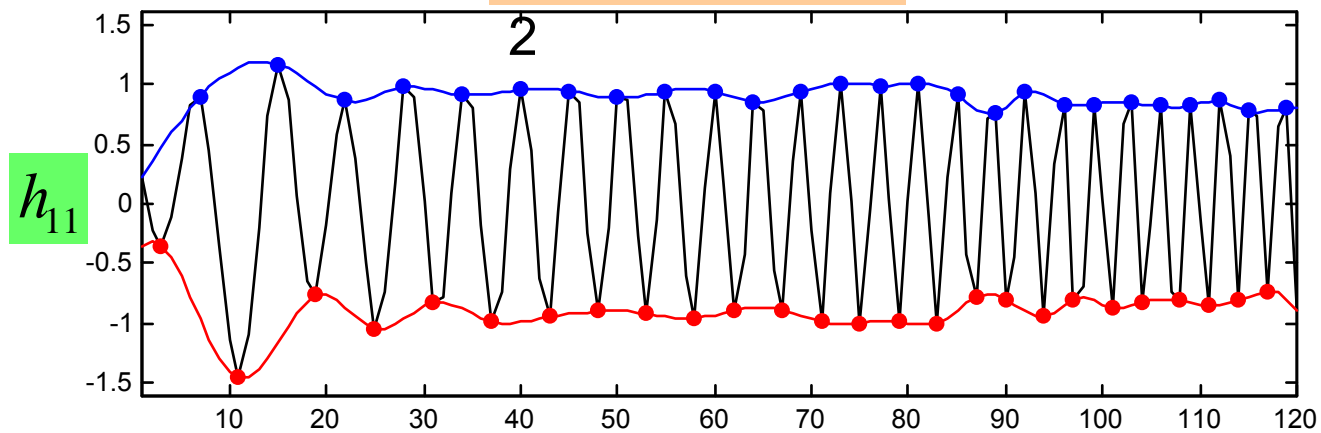

residue

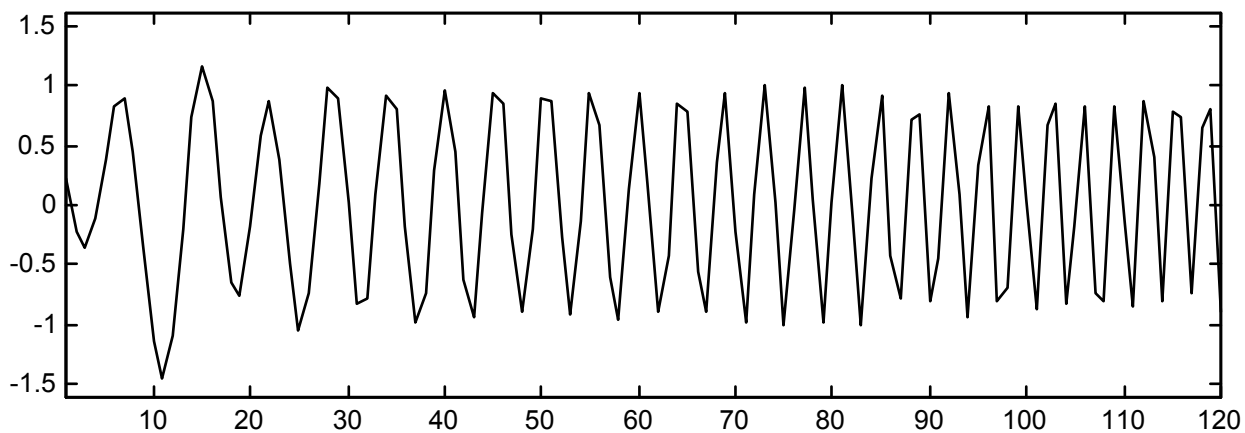

EMD 過程

IMF1, iteration

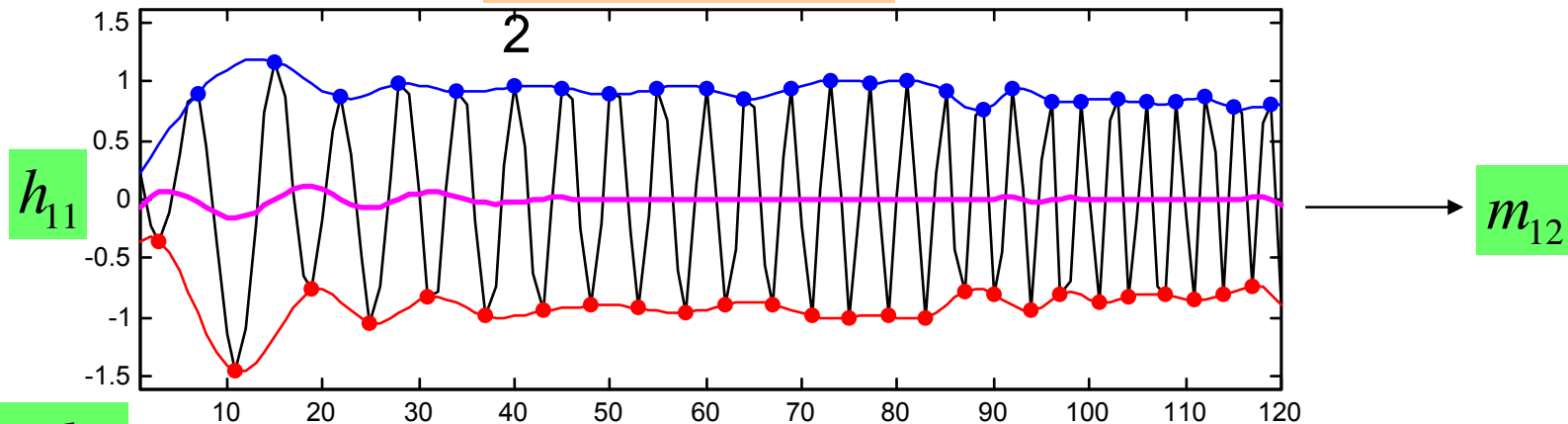

$$h_{11} - m_{12} = h_{12}$$

residue

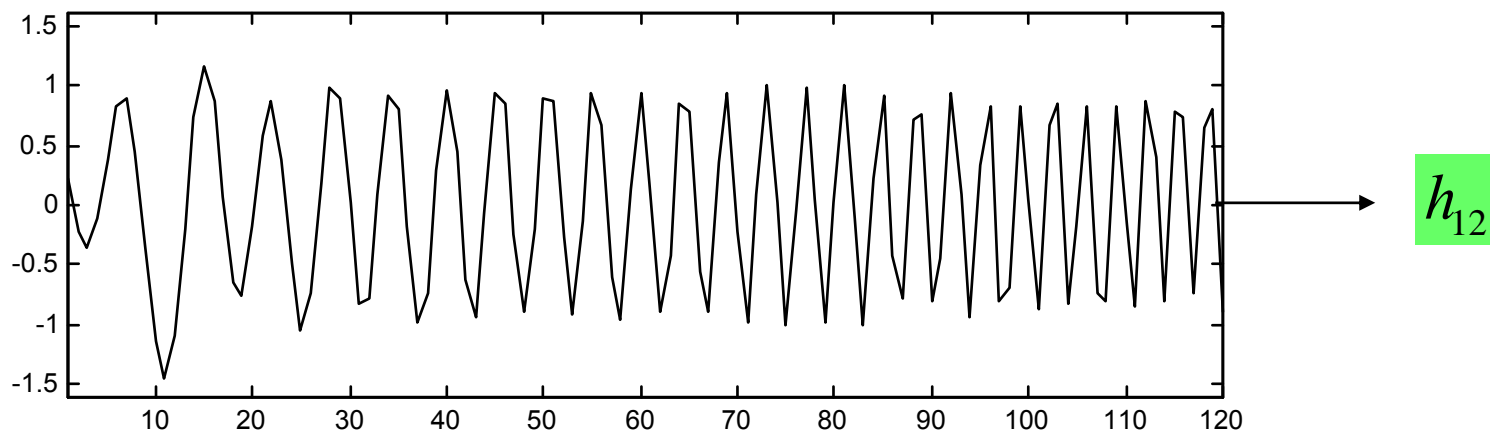

EMD 過程

IMF1, iteration

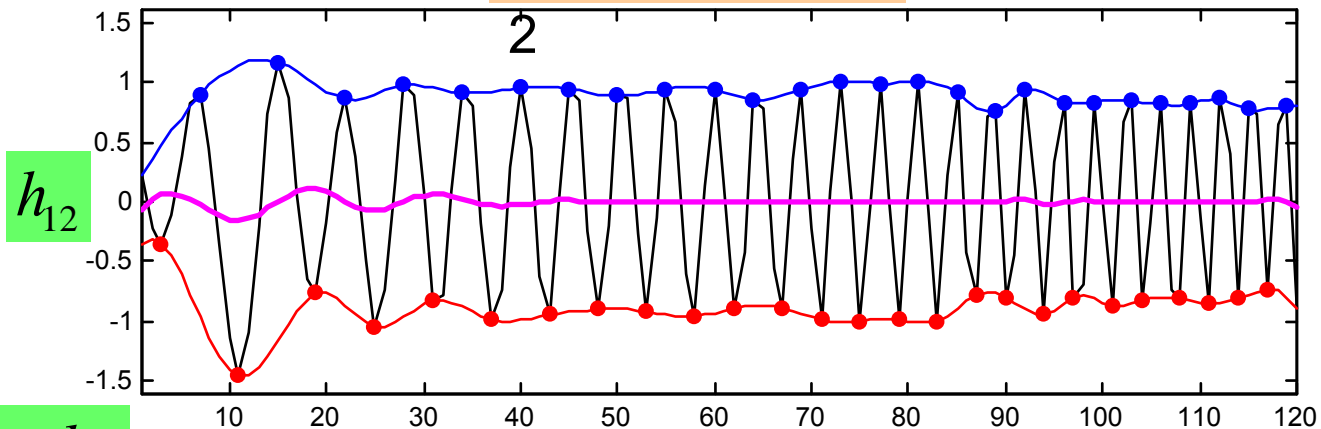

$$h_{12} - m_{13} = h_{13}$$

residue

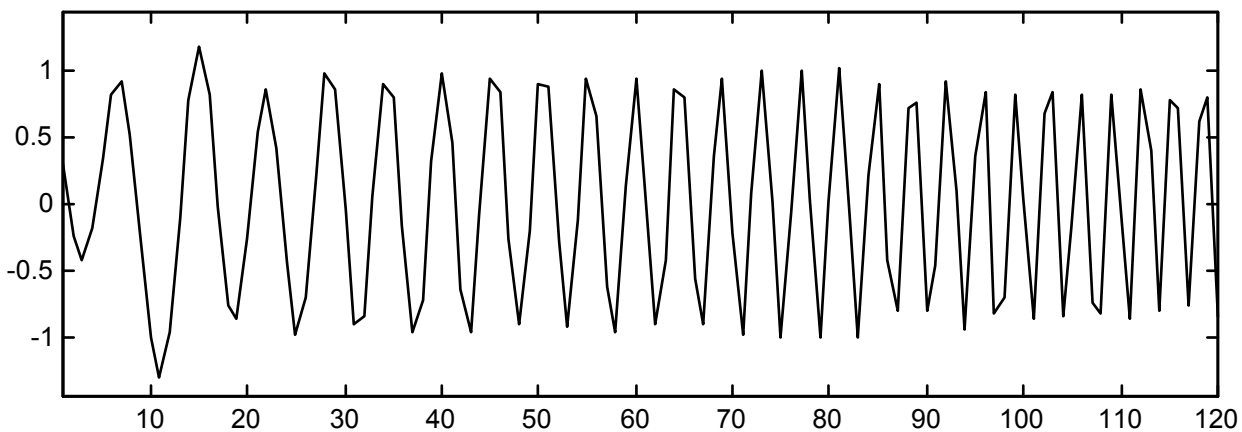

EMD 過程

IMF1, iteration

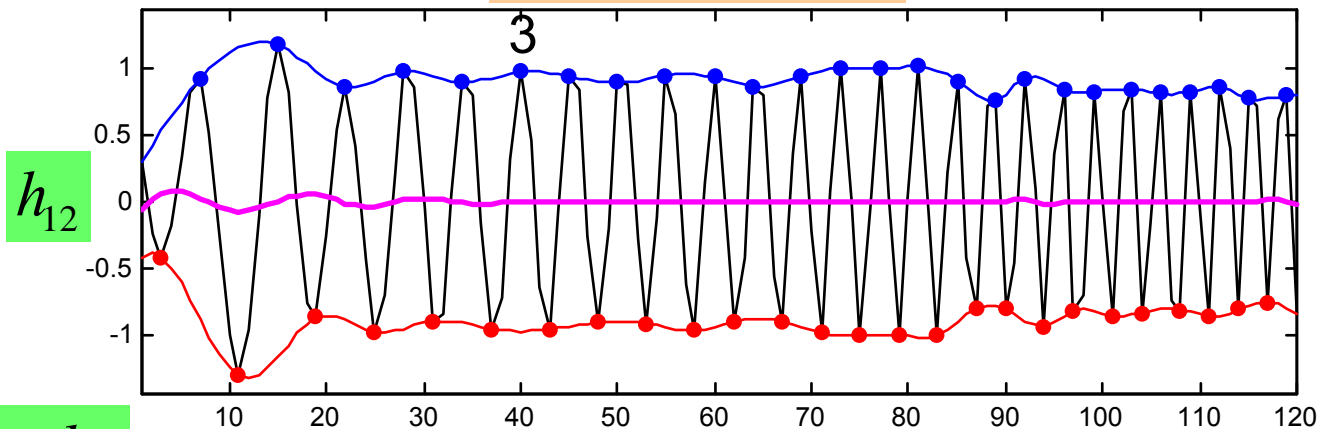

$$h_{12} - m_{13} = h_{13}$$

residue

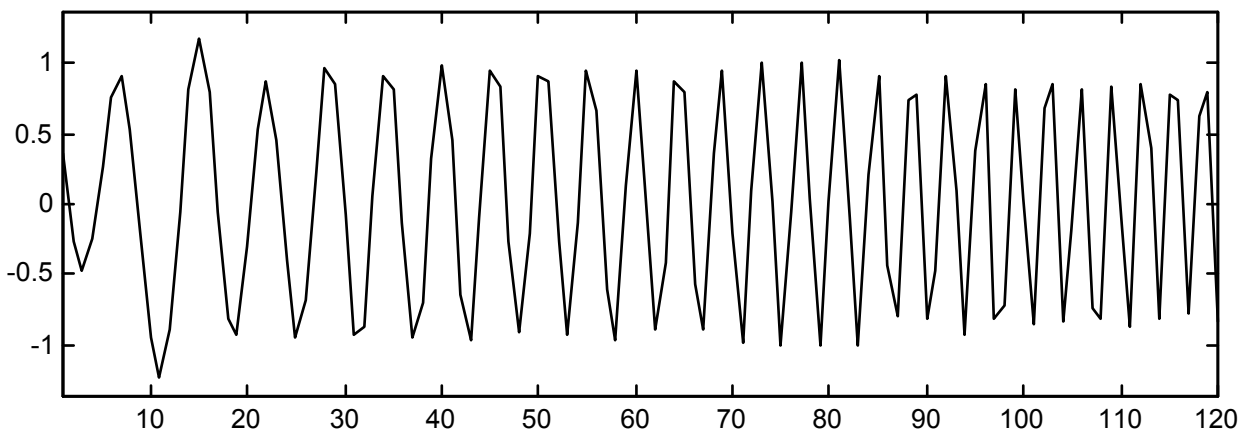

EMD 過程

IMF1, iteration

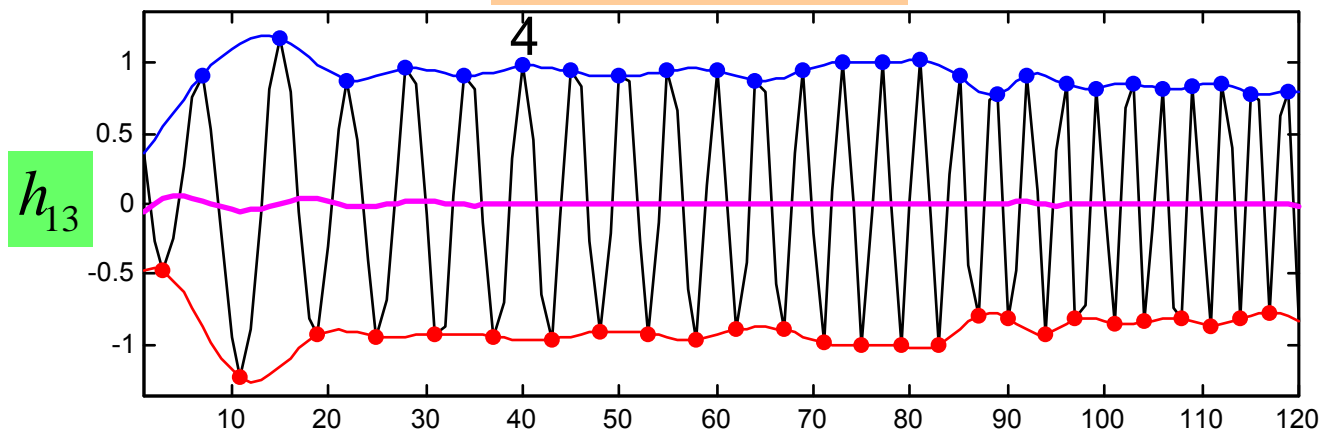

residue

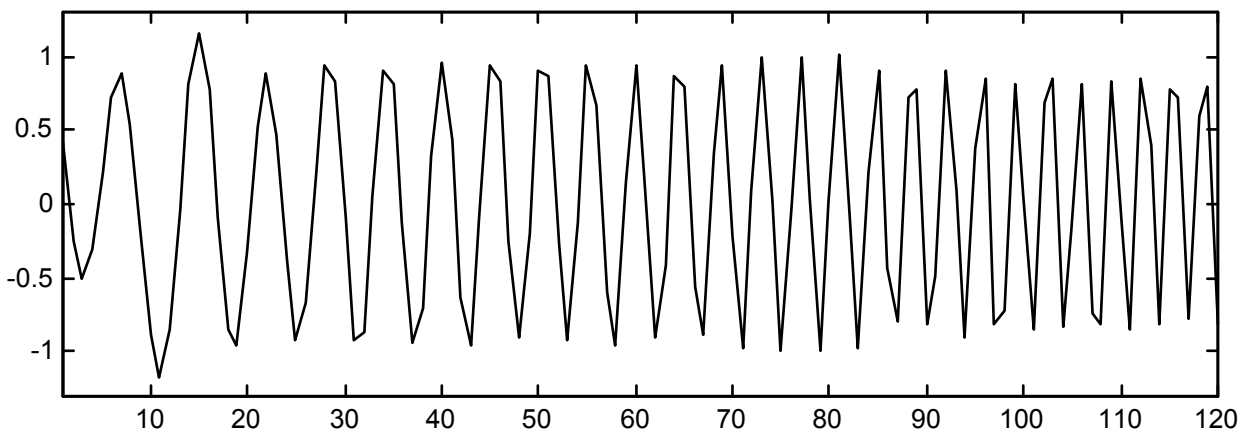

EMD 過程

IMF1, iteration

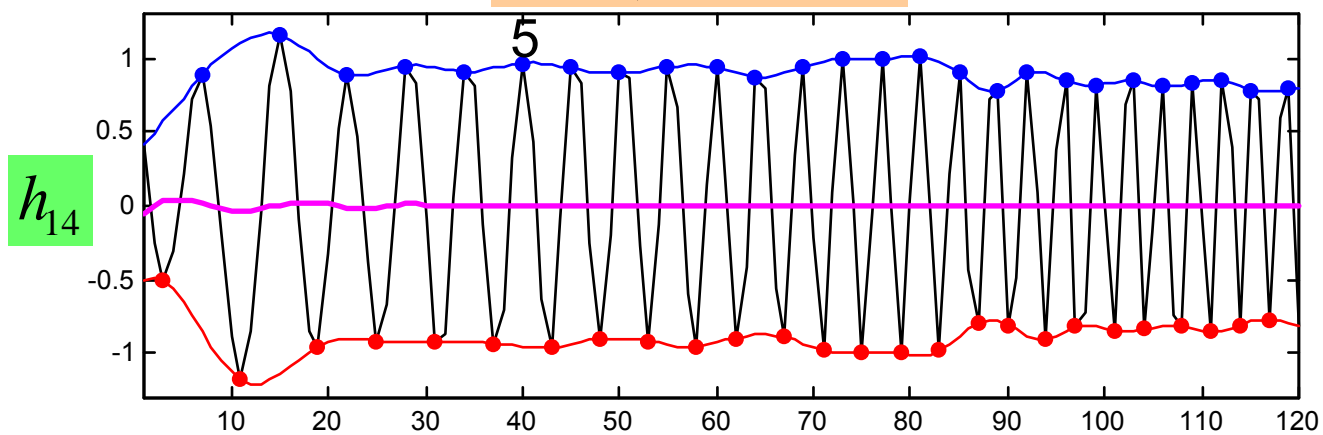

residue

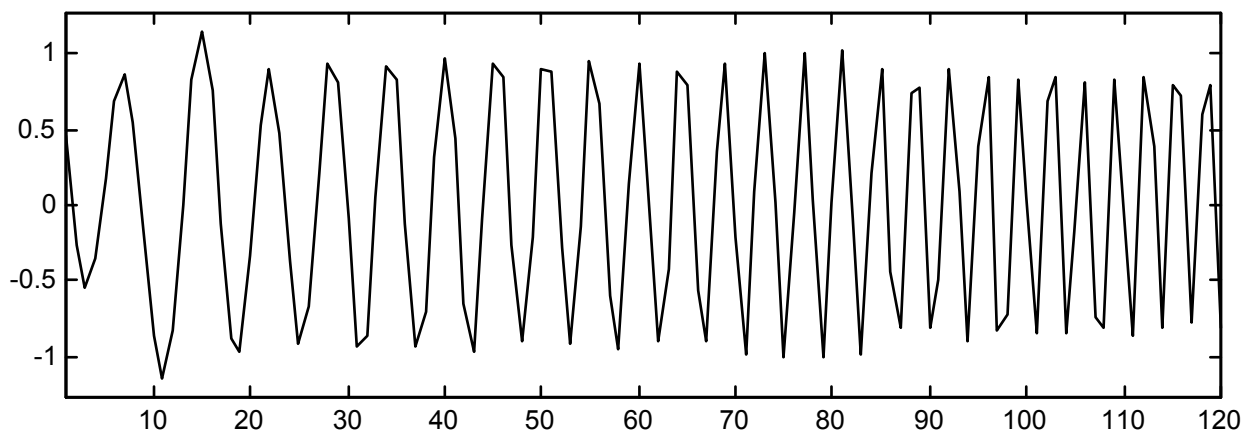

EMD 過程

IMF1, iteration

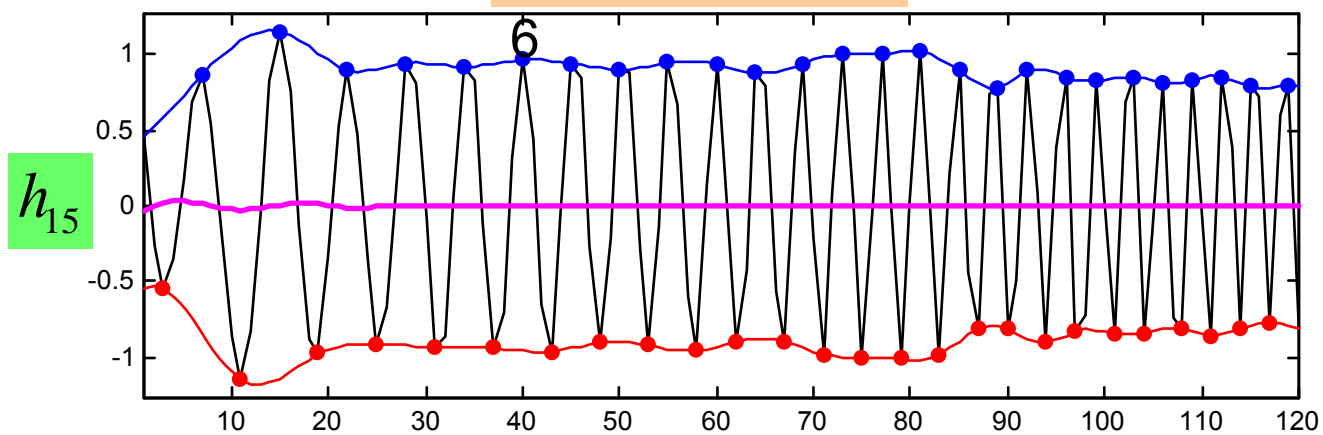

residue

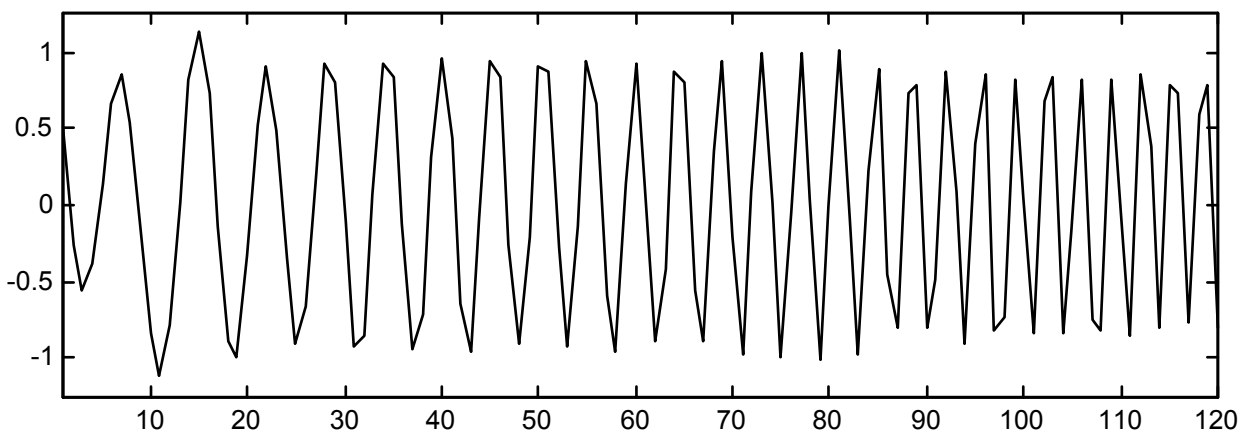

EMD 過程

IMF1, iteration

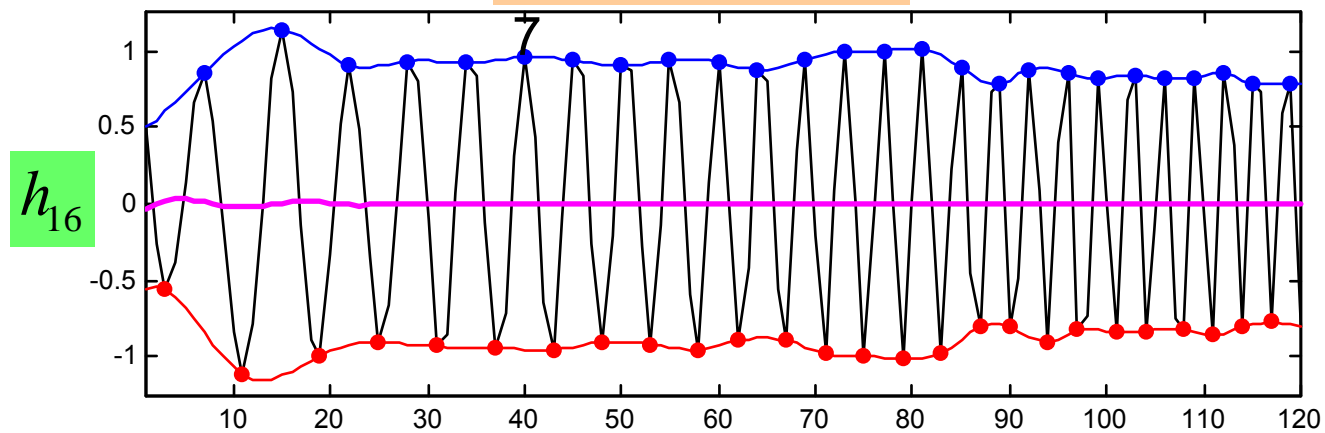

$h_{16} - m_{17} = h_{17}$

residue

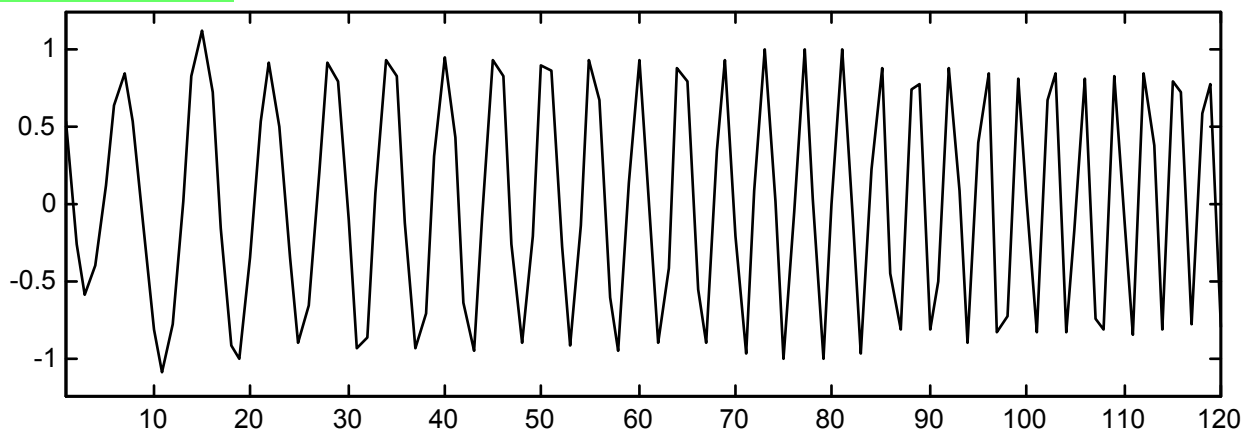

EMD 過程

$$SD = \left\{ \sum_{t=0}^T \left[\frac{|h_{1(k-1)}(t) - h_{1k}(t)|^2}{h_{1(k-1)}^2(t)} \right] \right\}^{1/2}$$

IMF1, iteration

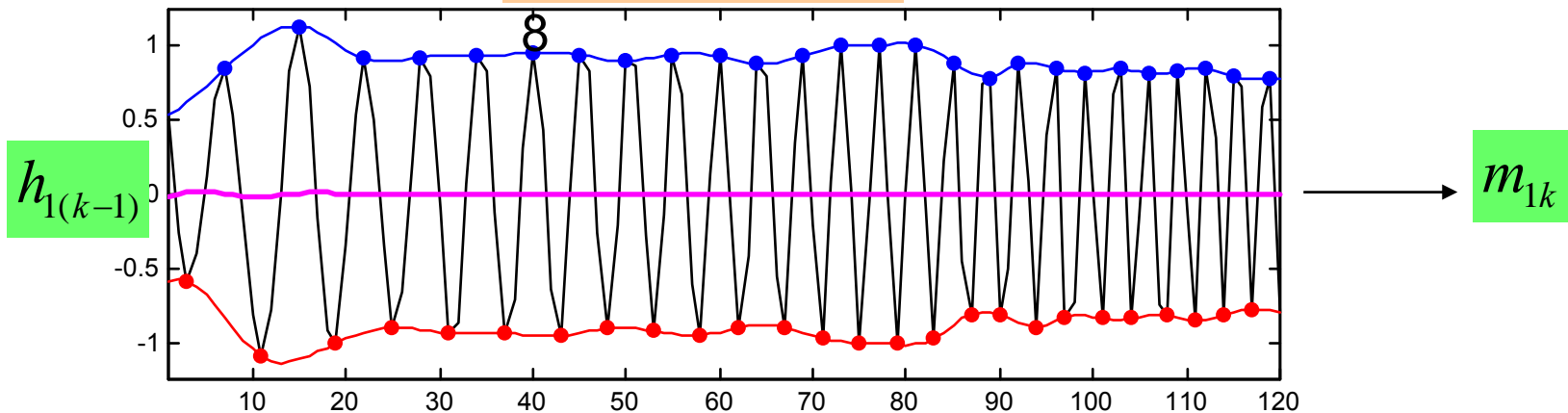

$$h_{1(k-1)} - m_{1k} = h_{1k}$$

residue

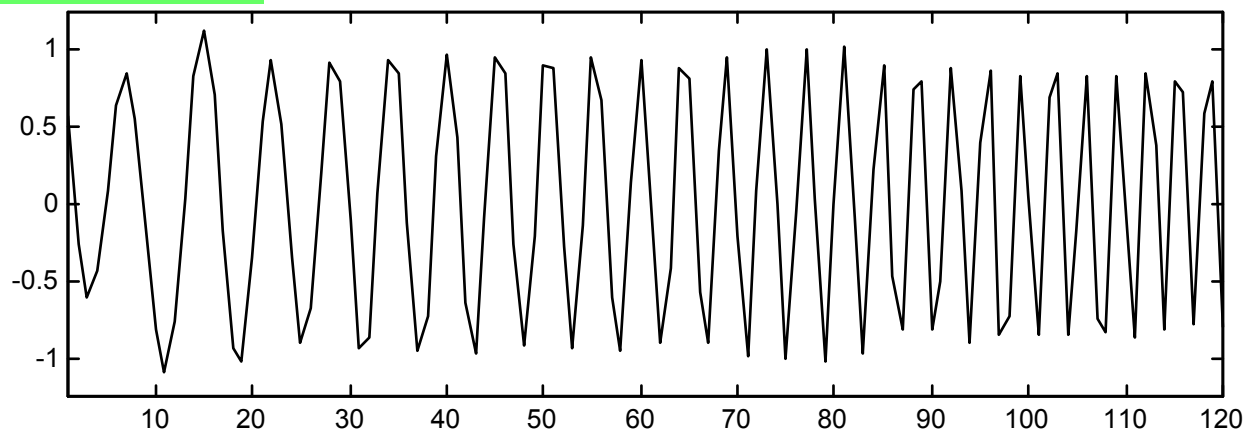

SD
< 0.1

c_1

IMF1

EMD 過程 (Empirical Mode Decomposition, EMD) 簡介

	IMF1	IMF2	IMF3	IMF n
	$X(t)$	$X(t) - c_1 = r_1$	$r_1 - c_2 = r_2$	$r_{n-2} - c_{n-1} = r_{n-1}$
0	$X(t) - m_{10} = h_{10}$	$r_1 - m_{20} = h_{20}$	$r_2 - m_{30} = h_{30}$	$r_{n-1} - m_{n0} = h_{n0}$
1	$h_{10} - m_{11} = h_{11}$	$h_{20} - m_{21} = h_{21}$	$h_{30} - m_{31} = h_{31}$	$h_{n0} - m_{n1} = h_{n1}$
2	$h_{11} - m_{12} = h_{12}$	$h_{21} - m_{22} = h_{22}$	$h_{31} - m_{32} = h_{32}$	$h_{n1} - m_{n2} = h_{n2}$
3	$h_{12} - m_{13} = h_{13}$	$h_{22} - m_{23} = h_{23}$	$h_{32} - m_{33} = h_{33}$	$h_{n2} - m_{n3} = h_{n3}$
	↓	↓	↓	↓
k	$h_{1(k-1)} - m_{1k} = h_{1k}$	$h_{2(k-1)} - m_{2k} = h_{2k}$	$h_{3(k-1)} - m_{3k} = h_{3k}$	$h_{n(k-1)} - m_{nk} = h_{nk}$
IMF	$h_{1k} = c_1$	$h_{2k} = c_2$	$h_{3k} = c_3$	$h_{nk} = c_n$

第1個 IMF

疊代 k 次



$$X(t) = \sum_{i=1}^n c_i + r_n$$



📖 希爾伯特-黃轉換處理架構流程圖

Empirical Mode Decomposition, EMD

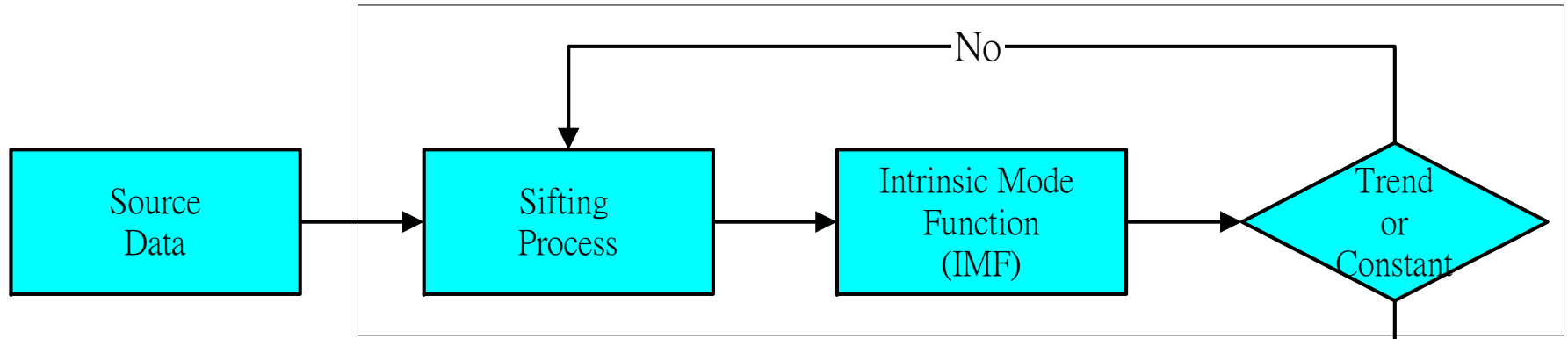

$$h(\omega) = \int_0^T H(\omega, t) dt$$

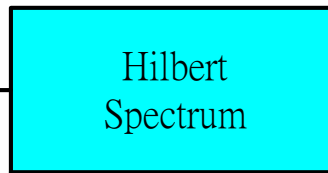
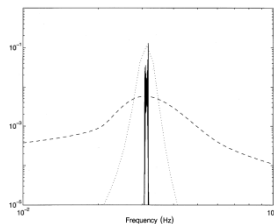

$$X(t) = \sum_{j=1}^n a_j(t) e^{i2\pi \int f_j(t) dt}$$

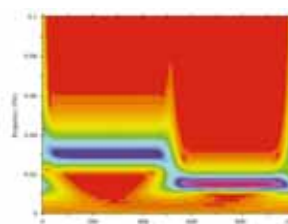

$$Y(t) = \frac{1}{\pi} PV \int_{-\infty}^{\infty} \frac{X(t')}{t-t'} dt'$$

Small wiggle effect

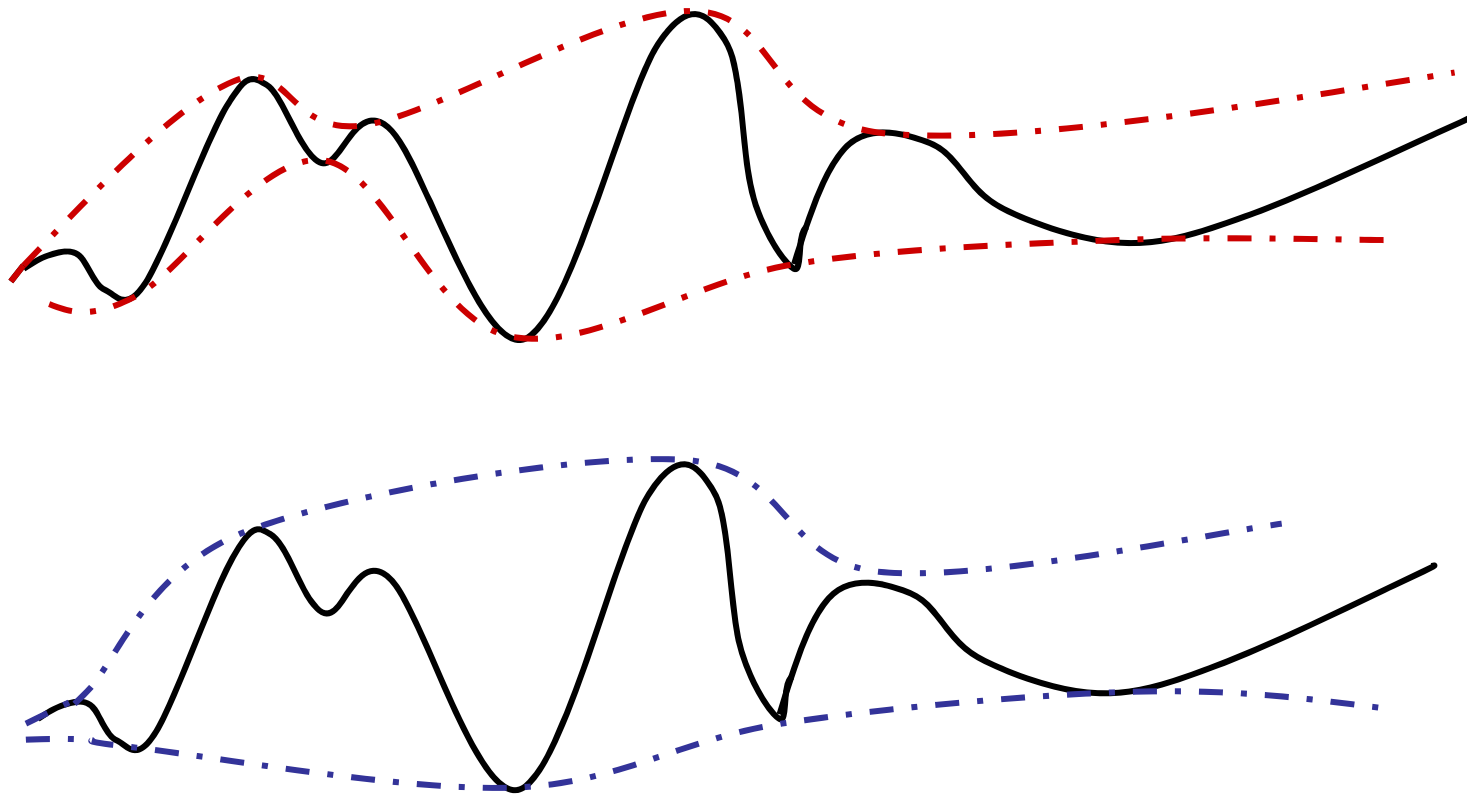

Small wiggling results in much difference in envelope.

Central lines with and without intermittency test

- Central line with intermittency test
- Central line without intermittency test
- Raw data

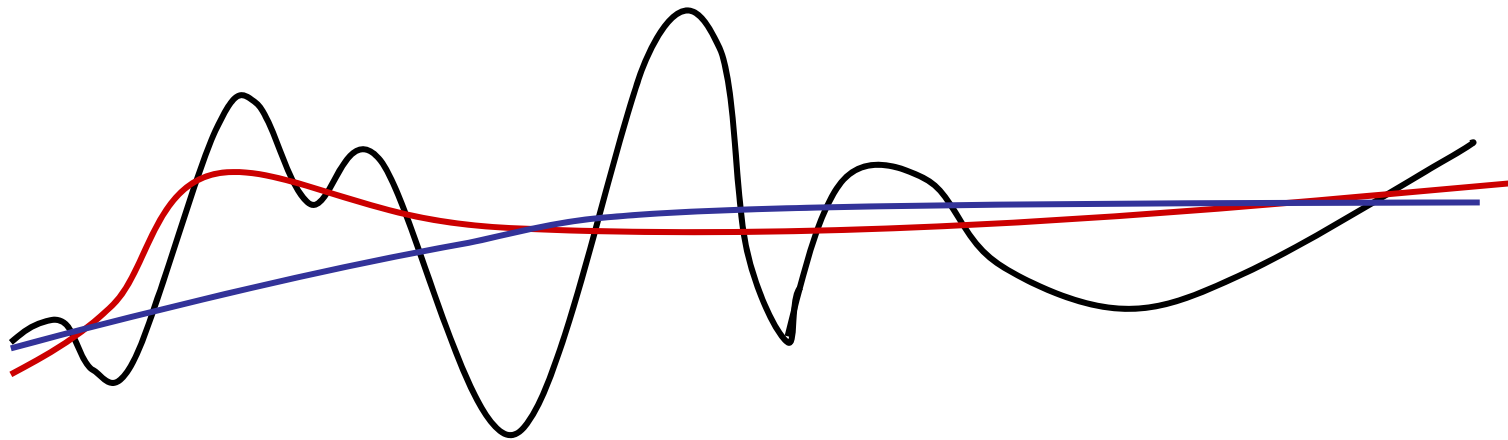

Intermittency Test

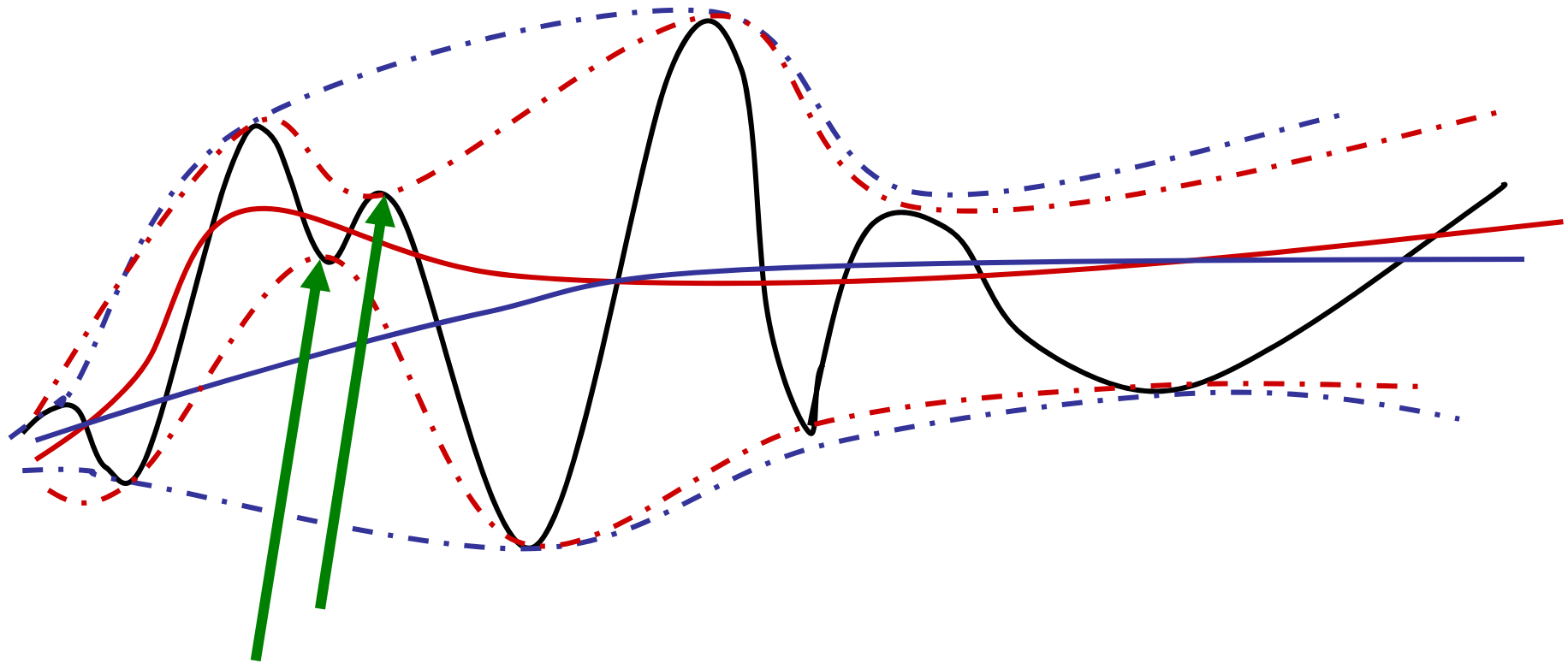

After intermittency test. There two points are not defined as extremas, resulting in smoother envelopes.

Intrinsic Mode Function (IMF)

- Definition: “Any function having the same numbers of zero-crossings and extrema, and also having symmetric envelopes defined by local maxima and minima respectively is defined as an Intrinsic Mode Function (IMF). “ ~ Norden E. Huang
- An IMF enjoys good properties of Hilbert transform.
- A signal can be regarded as composition of several IMFs. IMF can be obtained through a process called Empirical Mode Decomposition. (ref. Dr. Hsieh’s presentation file)

Instantaneous Frequency and Hilbert Transform

Prevailing Views of Instantaneous Frequency*

- The term, Instantaneous Frequency, should be banished forever from the dictionary of the communication engineer.
 - » J. Shekel, 1953
- The uncertainty principle makes the concept of an Instantaneous Frequency impossible.
 - » K. Grochennig, 2001

* Transcript of slide from Norden E. Huang

Definition of Frequency*

- Fourier Analysis
- Wavelet Analysis
- Wigner-Ville Analysis
- Dynamic System through Hamiltonian:

$$H(p, q, t) \quad \text{and wave action:} \quad A(t) = \int_0^{TC} p dq$$

$$\omega = \frac{\partial H}{\partial A}$$

- Teager Energy Operator
- Period between zero-crossings and extrema
- HHT analysis: $x(t) = \sum_j a(t) e^{i\theta_j(t)} \quad \omega_j = \frac{d\theta_j}{dt}$

* Transcript of slide from Norden E. Huang



The need for Instantaneous Frequency

- In classical wave theory, frequency is defined as time rate change of phase.
- Frequency is an continuous concept. There is need to clarify what we mean by frequency at a certain moment.
- Uncertainty principle does apply.

$$k = \nabla \varphi$$

$$\omega = - \frac{\partial \varphi}{\partial t}$$

$$\frac{\partial k}{\partial t} + \nabla \omega = 0$$

Instantaneous Frequency

- A time-series signal can be regarded as the x-axis projection of a planar slider motion. The slider moves along a rotating stick with axial velocity $\dot{a}(t)$, while the stick is spinning with an angular speed $\dot{\phi}(t)$.
- The corresponding y-axis projection shares the same frequency distribution as x-axis signal with 90 degree phase shift. Such conjugate signal is evaluated from Hilbert Transform.

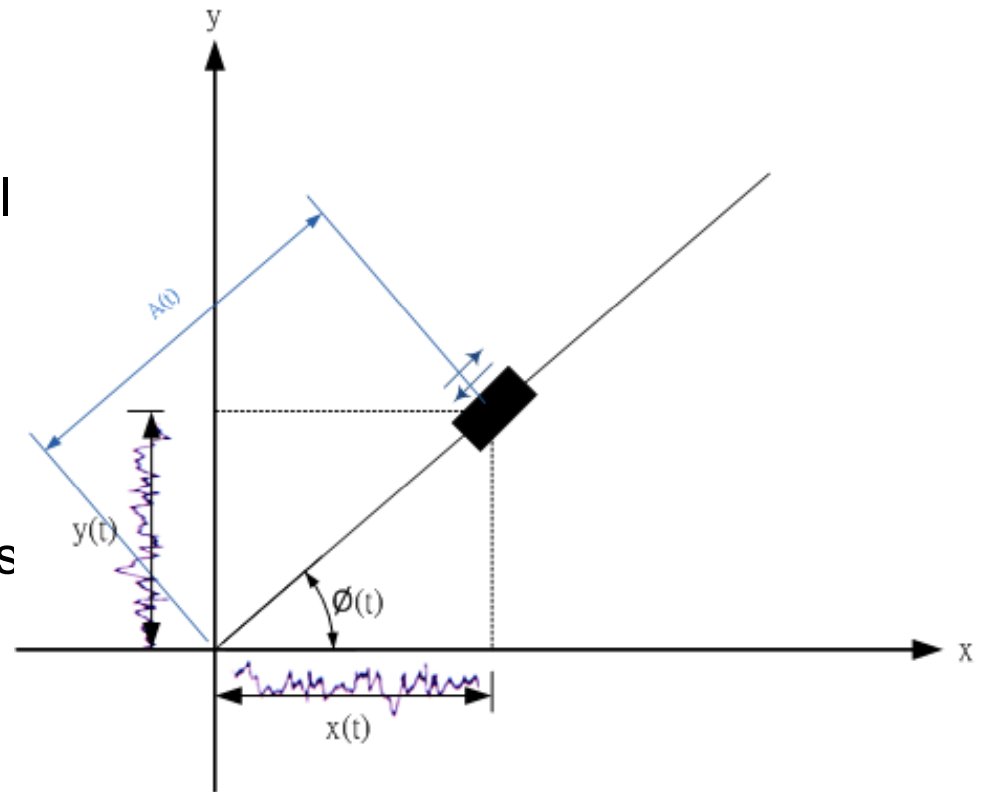

Hilbert Transform

$$y(t) = \frac{1}{\pi} PV \int \frac{x(\tau)}{t - \tau} d\tau$$

$$z(t) = x(t) + iy(t) = a(t)e^{i\varphi(t)}$$

$$a(t) = \sqrt{x^2 + y^2}$$

$$\varphi(t) = \tan^{-1} \frac{y(t)}{x(t)}$$

$$z(t) = \frac{2}{\sqrt{2\pi}} \int_0^\infty S(\omega) e^{i\omega t} d\omega$$

where

$$S(\omega) = \frac{1}{\sqrt{2\pi}} \int_{-\infty}^\infty x(t) e^{-i\omega t} dt$$

Instantaneous frequency: $\omega = -\frac{\partial \varphi}{\partial t}$

Hilbert transform of triangular signal

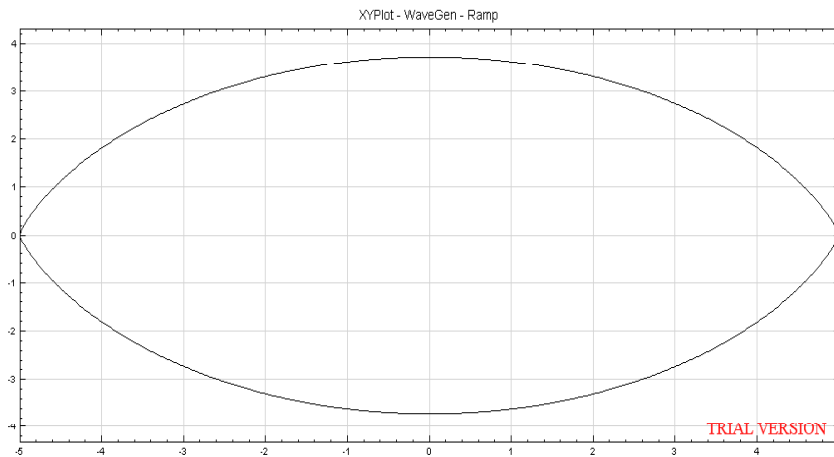
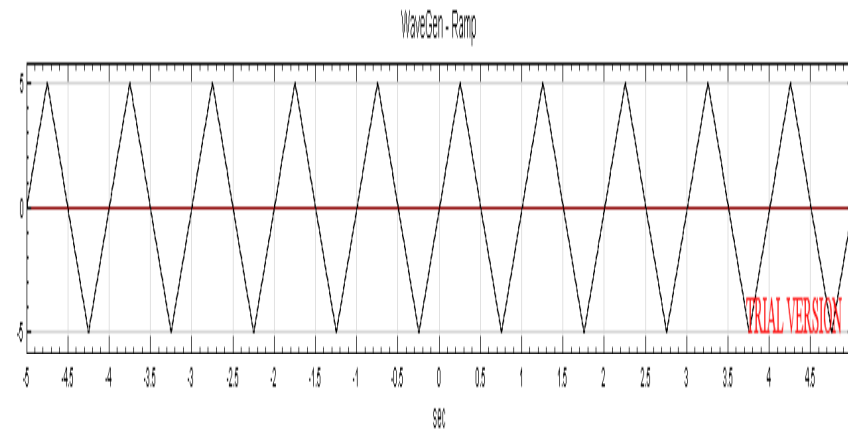

Phase diagram

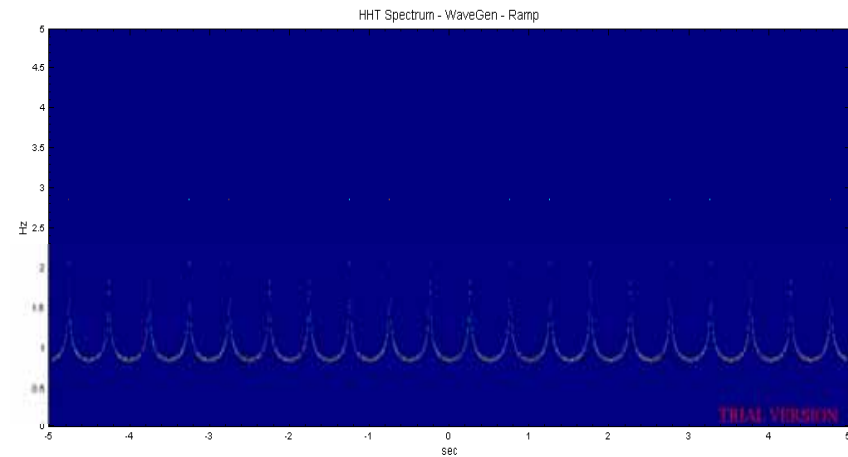

Hilbert spectrum

Drawback of Hilbert Transform

- Negative instantaneous frequency occurs for signal not having equal number of extreme and zero-crossing points.
- Too much DC offset also results in negative frequency.

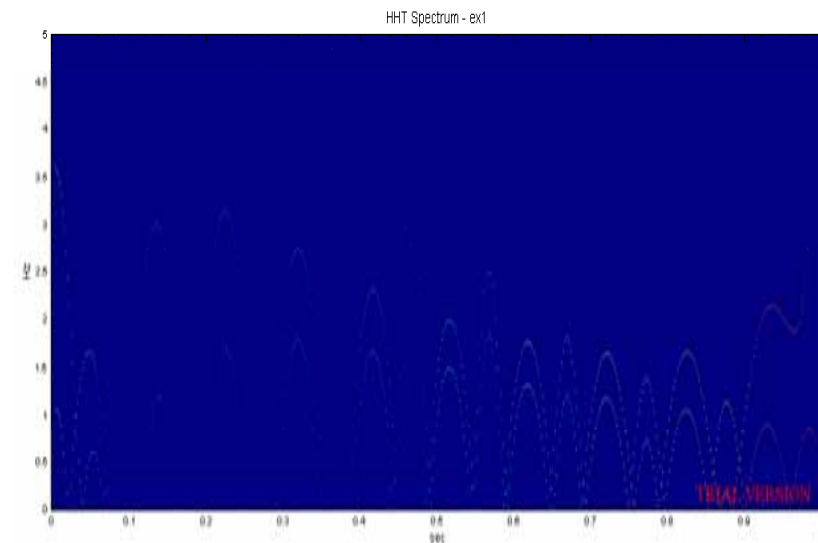
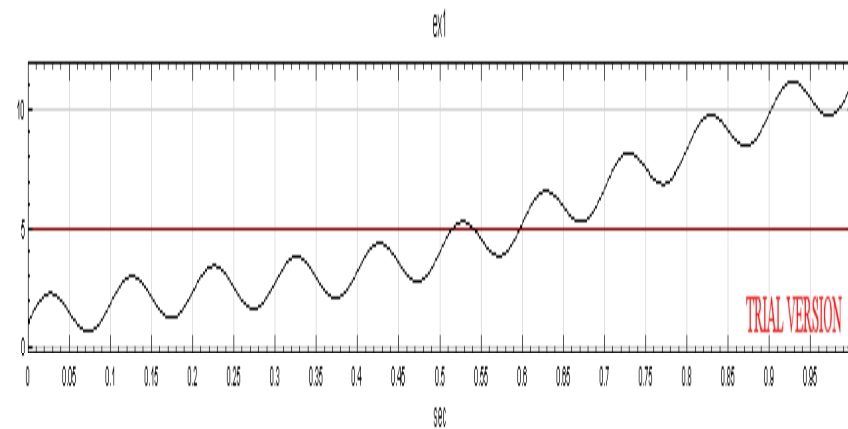
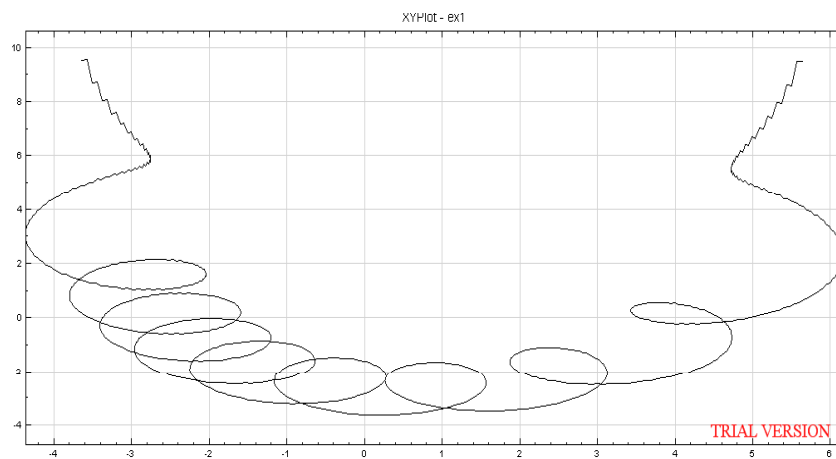

Example 1:

$$\cos(2\pi \cdot 10 \cdot t + 0.3 \cdot \sin(2\pi \cdot 20 \cdot t))$$

Raw data

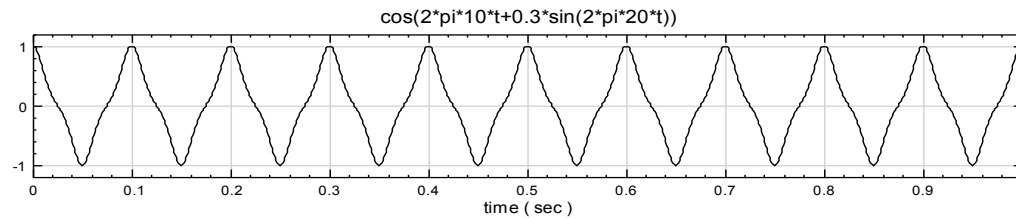

Analytical signal

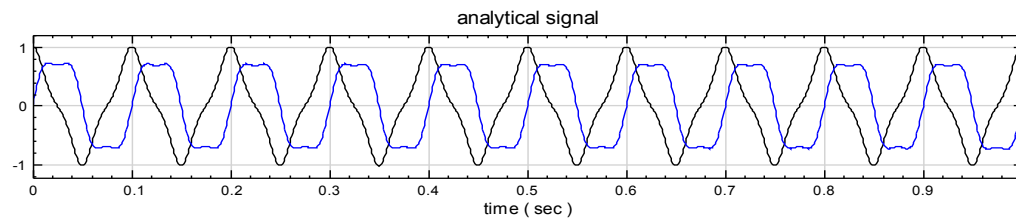

Instantaneous amplitude

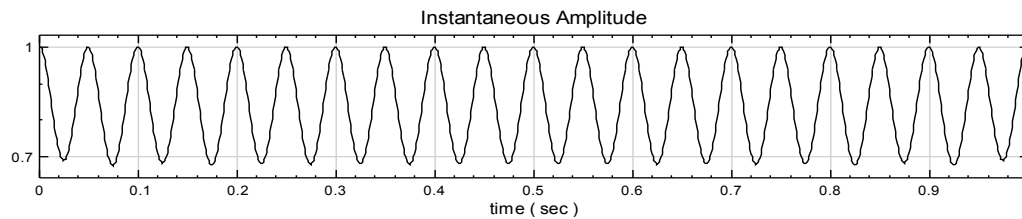

Instantaneous frequency

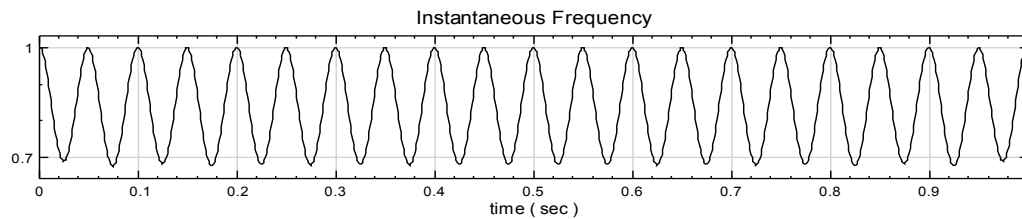

Hilbert Spectrum and X-Y Plot

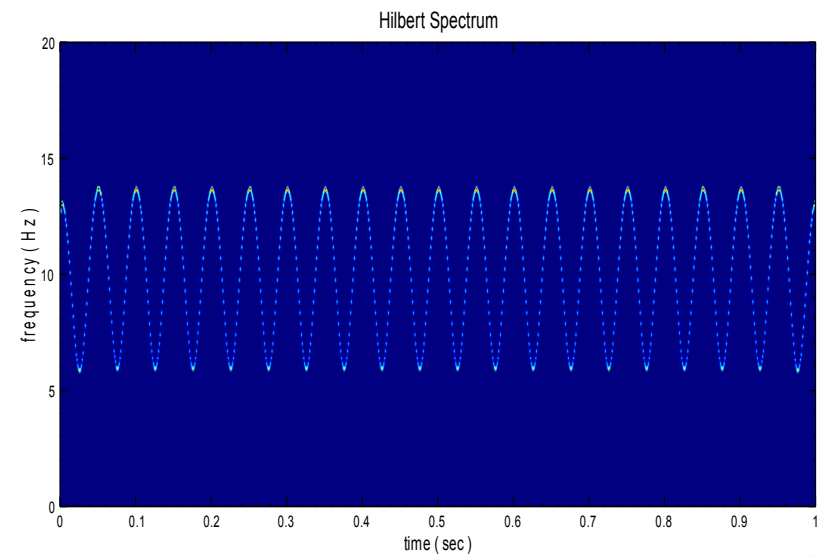
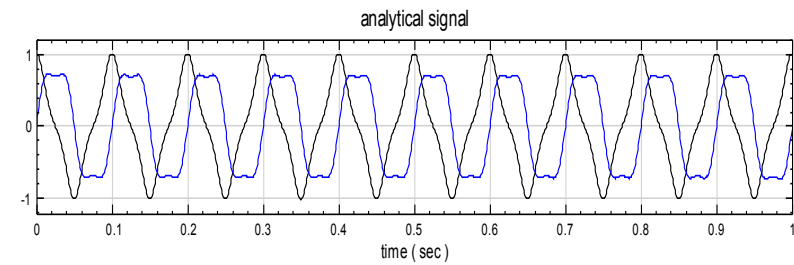
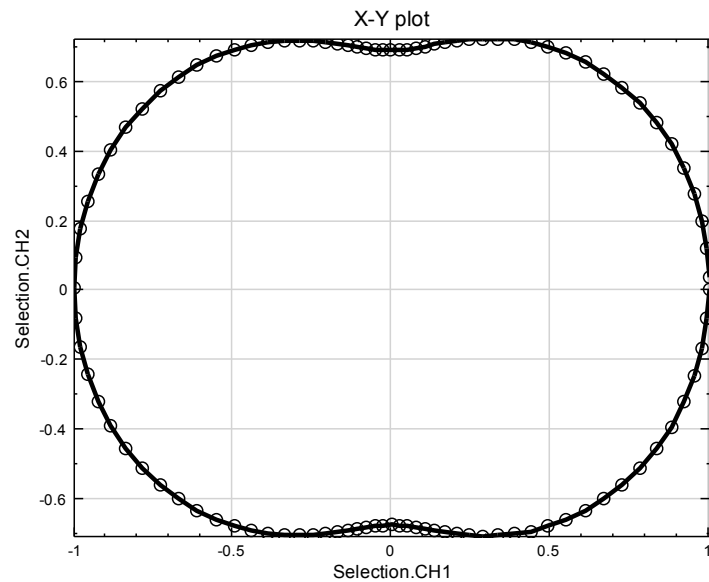

Example 2

$$\cos(2\pi \cdot 10 \cdot t + 0.3 \cdot \sin(2\pi \cdot 20 \cdot t)) + \cos(2\pi \cdot 26 \cdot t) + 0.5 \cdot t$$

Raw data

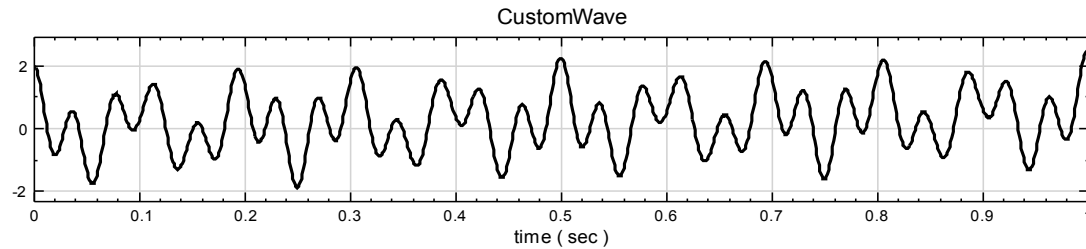

Analytical signal

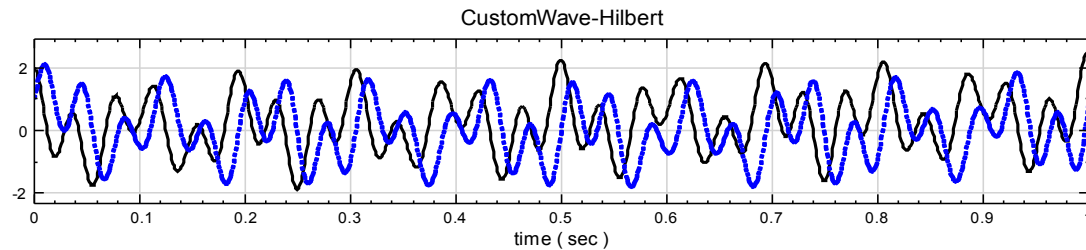

Instantaneous amplitude

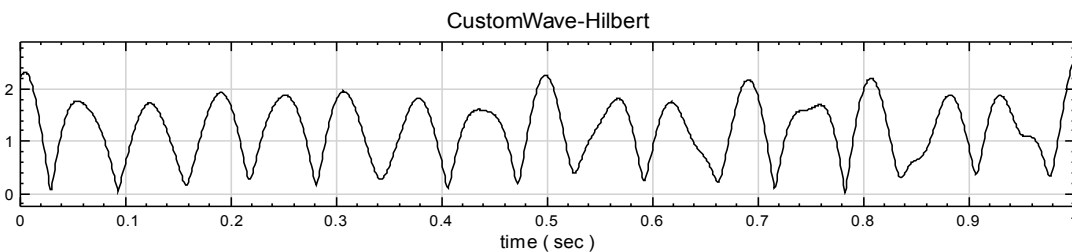

Instantaneous frequency

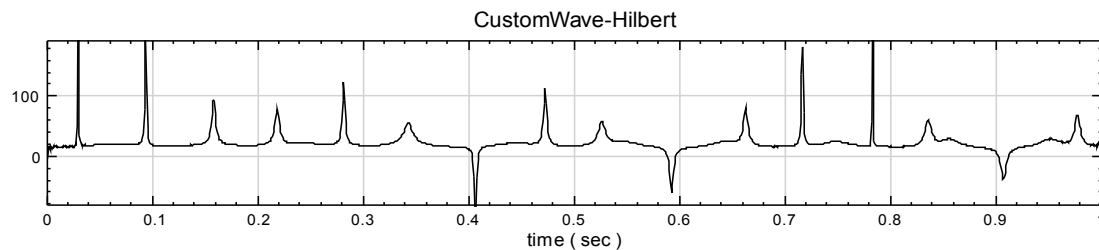

Hilbert Spectrum and X-Y Plot

Line crossing in X-Y plot suggests existence of negative frequency.

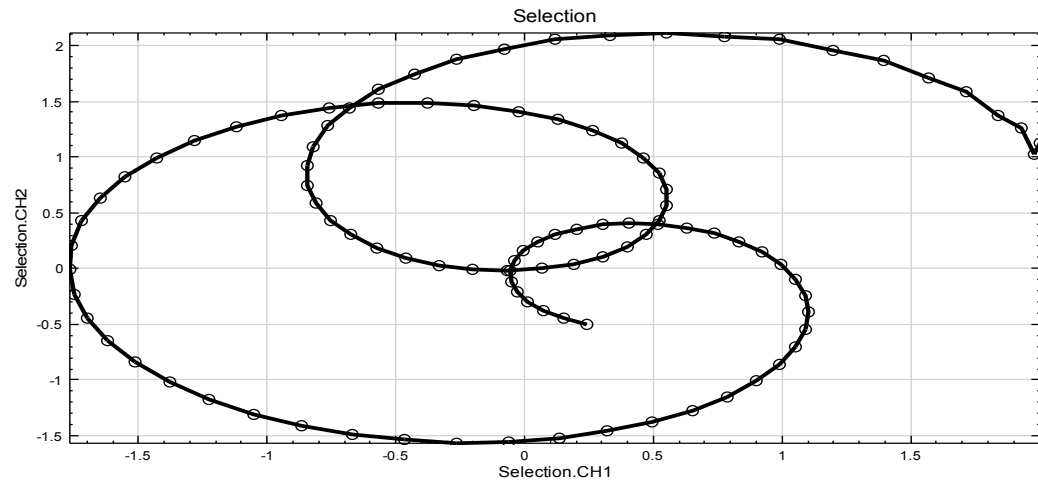

Hilbert Spectrum

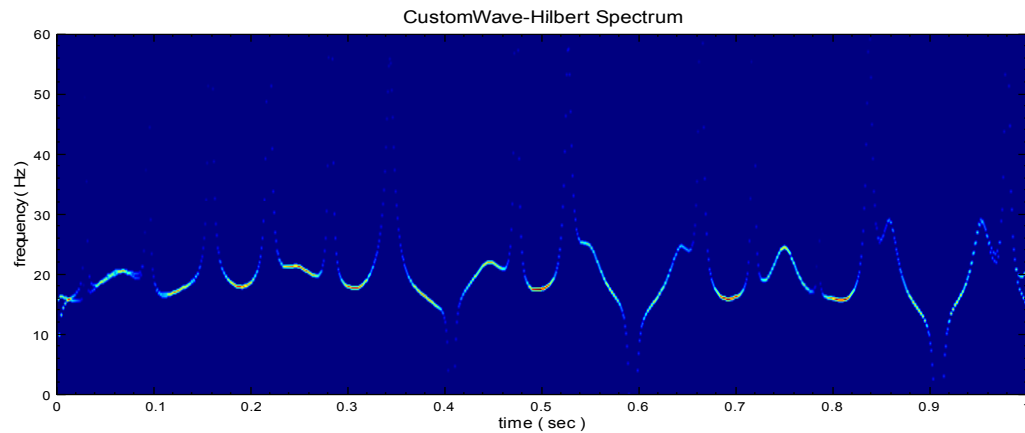

EMD

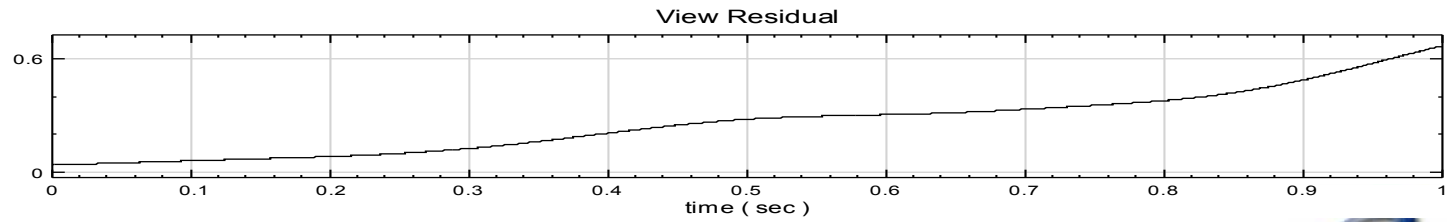
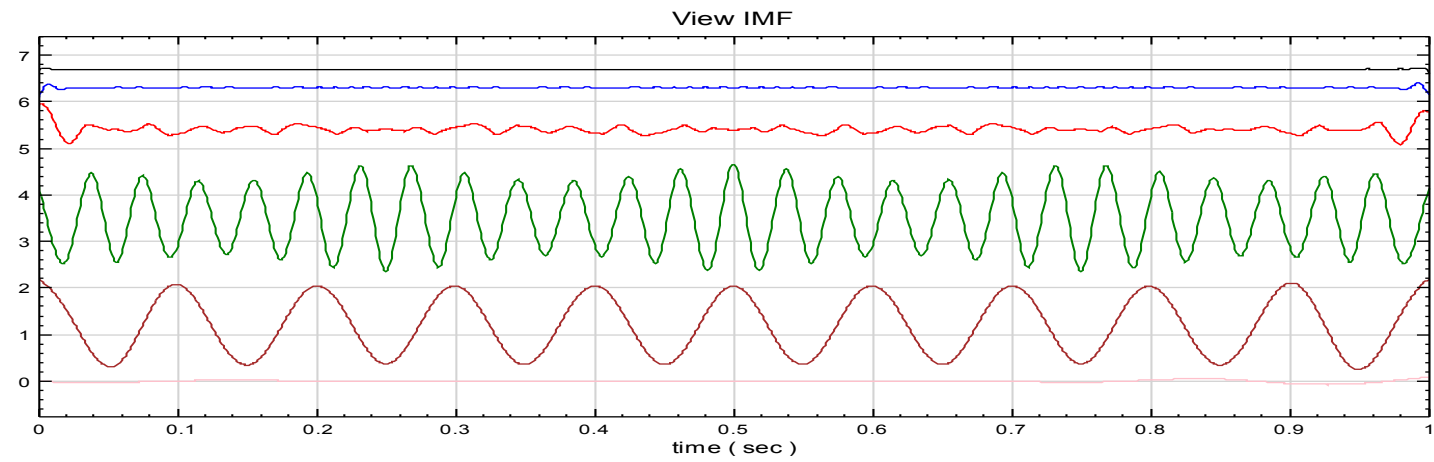
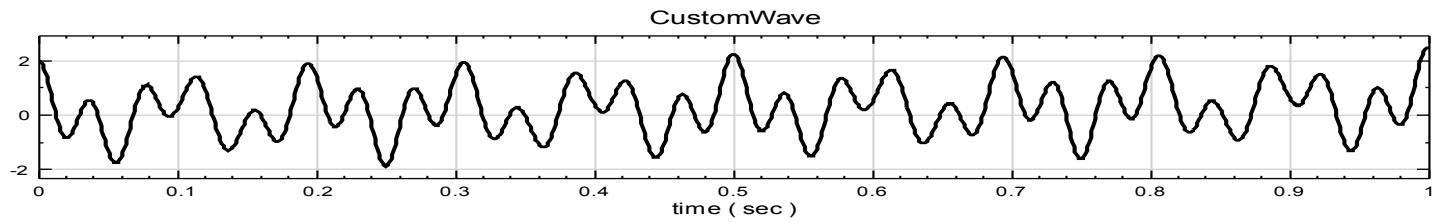

Hilbert Spectrum Comparison

Raw data

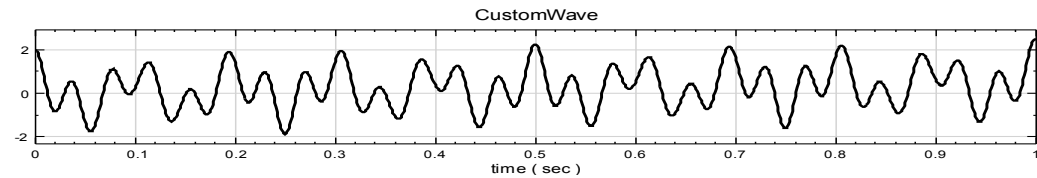

Hilbert spectrum after EMD

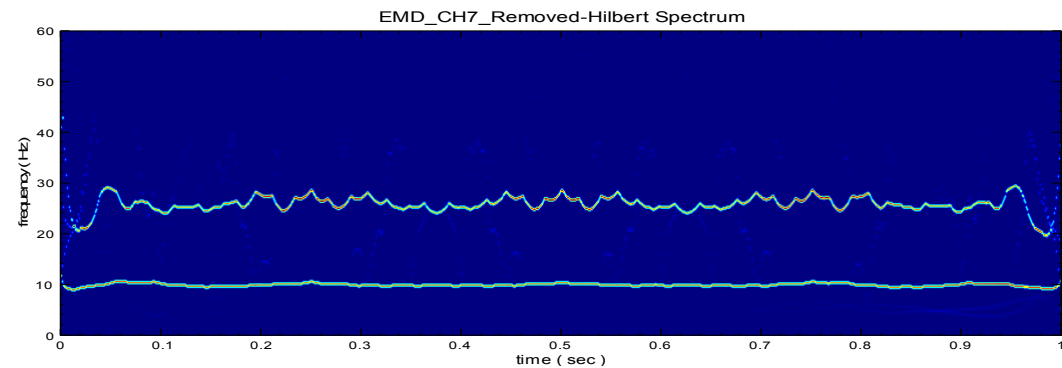

Hilbert spectrum of raw data

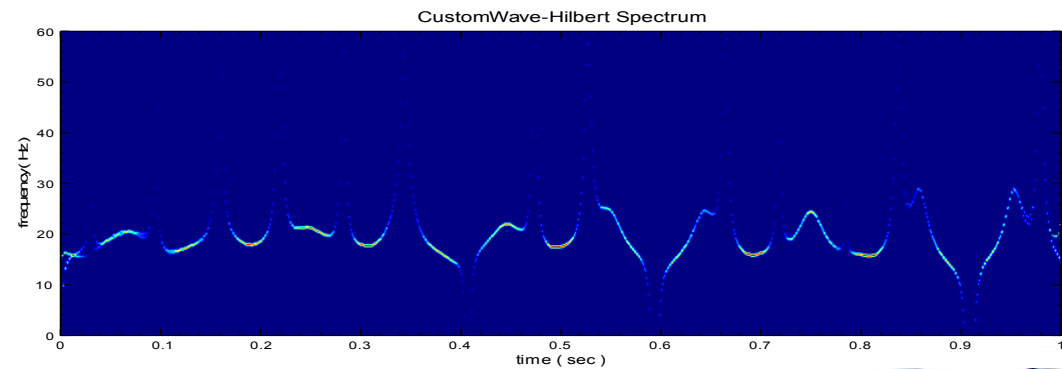

Limitation on Hilbert Transform*

- Data need to be mono-component. Traditional applications using band-pass filter, which distorts the wave form. (EMD Resolves this problem)
- Bedrosian Theorem: Hilbert transform of $[a(t) \cos \omega(t)]$ might not be exactly $[a(t) \sin \omega(t)]$ for arbitrary a and ω . (Normalized HHT resolves this)
- Nuttall Theorem: Hilbert transform of $\cos \omega(t)$ might not be exactly $\sin \omega(t)$ for arbitrary $\omega(t)$. (Normalized HHT improved on the error bound).
- But we have to realize that the Instantaneous Frequency is always an approximation.

* Transcript of slide from Norden E. Huang

Limitation for IF computed through Hilbert Transform*

- Data must be expressed in terms of Simple Oscillatory Function (aka Intrinsic Mode Function). (Note: Traditional applications using band-pass filter distorts the wave form; therefore, it can only be used for linear processes.) IMF is only necessary but not sufficient.
- Bedrosian Theorem: Hilbert transform of $a(t)\cos\theta(t)$ might not be exactly $a(t)\sin\theta(t)$. Spectra of $a(t)$ and $\cos\theta(t)$ must be disjoint.
- Nuttall Theorem: Hilbert transform of $\cos\theta(t)$ might not be $\sin\theta(t)$ for an arbitrary function of $\theta(t)$. Quadrature and Hilbert Transform of arbitrary real functions are not necessarily identical.
- Therefore, simple derivative of the phase of the analytic function might not work.

* Transcript of slide from Norden E. Huang



Bedrosian Theorem*

- Let $f(x)$ and $g(x)$ denote generally complex functions in $L^2(-\infty, \infty)$ of the real variable x . If
 - (1) The Fourier transform $F(\omega)$ of $f(x)$ vanishes for $\omega > a$ and the Fourier transform $G(\omega)$ of $g(x)$ vanishes for $\omega < a$, where a is an arbitrary positive constant, or
 - (2) $f(x)$ and $g(x)$ are analytic (i.e., their real and imaginary parts are Hilbert pairs),then the Hilbert transform of the product of $f(x)$ and $g(x)$ is given $H\{f(x)g(x)\} = f(x)H\{g(x)\}$.

Bedrosian, E. 1963: A Product theorem for Hilbert Transform, Proceedings of IEEE, 51, 868-869.

* Transcript of slide from Norden E. Huang



Nuttal Theorem*

- For any function $x(t)$, having a quadrature $x_q(t)$, and a Hilbert transform $x_h(t)$; then,

$$\begin{aligned} E &= \int_0^{\infty} |x_q(t) - x_h(t)|^2 dt \\ &= 2 \int_{-\infty}^0 |F_q(\omega)|^2 d\omega \end{aligned}$$

where $F_q(\omega)$ is the spectrum of $x_q(t)$.

Nuttal, A. H., 1966: On the quadrature approximation to the Hilbert Transform of modulated signal, Proc. IEEE, 54, 1458

* Transcript of slide from Norden E. Huang



Difficulties with the Existing Limitations*

- We can use EMD to obtain the IMF.
- IMF is only necessary but not sufficient.
- Bedrosian Theorem adds the requirement of not having strong amplitude modulations.
- Nuttall Theorem further points out the difference between analytic function and quadrature. The discrepancy is given in term of the quadrature spectrum, which is an unknown quantity. Therefore, it cannot be evaluated.
- Nuttall Theorem provides a constant limit not a function of time; therefore, it is not very useful for non-stationary processes.

* Transcript of slide from Norden E. Huang

Instantaneous Frequency: different methods

- Teager Energy Operator
- Normalized IMF
- Generalized Zero-Crossing

Instantaneous Energy Consideration

- Energy of a signal is normally defined as sum of square of amplitude. For signals of different frequencies with same oscillatory amplitude appear to have same “signal energy.”
- In many real situation, energy needed for generating 100Hz signal is much greater than that of 10Hz, even though the amplitudes are the same.
- If signal is generated by physical devices with rotation motion, instantaneously the energy is related to kinetic motion $dx(t)/dt$ and instant work done by the motion.

Teager Energy Operator

Lie Bracket

$$[x, y] = \dot{x}y - x\dot{y}$$

$$[x, y] / xy = \dot{x} / x - \dot{y} / y$$

If $y = \dot{x}$

Energy Operator:

$$\psi(x) = (\dot{x})^2 - x\ddot{x} = [x, \dot{x}]$$

DESA-1

Discrete energy operator:

$$\psi(x(n)) = x(n)^2 - x(n-1)x(n+1)$$

Instantaneous frequency

$$\Omega = \cos^{-1} \left(1 - \frac{\psi(x(n)) - x(n-1)}{2\psi(x(n))} \right)$$

Amplitude

$$A = \left(\frac{\psi(x(n))}{1 - \left(1 - \frac{\psi(x(n)) - x(n-1)}{2\psi(x(n))} \right)^2} \right)^{1/2}$$

Comparison of Different Methods*

- TEO extremely local but for linear data only.
- GZC most stable but offers only smoothed frequency over $\frac{1}{4}$ wave period at most.
- HHT elegant and detailed, but suffers the limitations of Bedrosian and Nuttall Theorems.
- NHHT, with Normalized data, overcomes Bedrosian limitation, offers local, stable and detailed Instantaneous frequency and Error Index for nonlinear and nonstationary data.

* Transcript of slide from Norden E. Huang



Five Paradoxes on Instantaneous Frequency (a la Leon Cohen)*

- Instantaneous frequency of a signal may not be one of the frequencies in the spectrum.
- For a signal with a line spectrum consisting of only a few sharp frequencies, the instantaneous frequency may be continuous and range over an infinite number of values.
- Although the spectrum of analytic signal is zero for negative frequency, the instantaneous frequency may be negative.
- For the band limited signal the instantaneous frequency may be outside the band.
- The value of the Instantaneous frequency should only depend on the present time, but the analytic signal, from which the instantaneous frequency is computed, depends on the signal values for the whole time space.

* Transcript of slide from Norden E. Huang



Observations*

- Paradoxes 1, 2 and 4 are essentially the same: Instantaneous Frequency values may be different from the frequency in the spectrum.
- The negative frequency in analytical signal seems to violate Gabor's construction.
- The analytic function, or the Hilbert Transform, involves the functional values over the whole time domain.

* Transcript of slide from Norden E. Huang



The advantages of using HHT

- Removal of non-periodical part
- Separation of carrier frequency: even though the spectrum is close. Such function can be hardly achieved by frequency based filter.
- Nonlinear effect might introduce frequency harmonics in spectrum domain. Through HHT, the nonlinear effect can be caught by EMD/IMF. The marginal frequency therefore enjoys shorter band width.
- Average frequency in each IMF represents intrinsic signature of physics behind the data.
- Signal can be regarded as generated from rotors of different rotating speeds (analytical signals).

Comparison*

	Fourier	Wavelet	Hilbert
Basis	a priori	a priori	Adaptive
Frequency	Convolution: Global	Convolution: Regional	Differentiation: Local
Presentation	Energy-frequency	Energy-time- frequency	Energy-time- frequency
Nonlinear	no	no	yes
Non-stationary	no	yes	yes
Feature extraction	no	Discrete: no Continuous: yes	yes

* Transcript of slide from Norden E. Huang



Outstanding Mathematical Problem*

- Adaptive data analysis methodology in general
- Nonlinear system identification methods
- Prediction problem for nonstationary processes (end effects)
- Optimization problem (the best IMF selection and uniqueness. Is there a unique solution?)
- Spline problem (best spline implement of HHT, convergence and 2-D)
- Approximation problem (Hilbert transform and quadrature)

* Transcript of slide from Norden E. Huang



Summary*

- The so called paradoxes are really not problems, once some misconceptions are clarified.
- Instantaneous Frequency (IF) has very different meaning than the Fourier frequency.
- IF for special mono-component functions only: IMFs.
- Even for IMFs, there are still problems associated with Hilbert Transform. We have to use Normalized HHT to compute the IF.
- IF is always an approximation.

* Transcript of slide from Norden E. Huang



Suggested Readings

- Leon Cohen, “Time-Frequency Analysis,” Prentice Hall Signal Processing Series
- Norden E. Huang, “Hilbert-Huang Transformation 方法原理，應用與未來發展,” View Graph, 中央大學，94年4月20日
- Richard A. Roberts & Clifford T. Mullis, “Digital Signal Processing,” Addison Wesley
- Robert A. Gabel & Richard A. Roberts, “Signal And Linear Systems,” 3rd Edition, Wiley
- Jerrold E. Marsden, “Basic Complex Analysis,” Mei Ya
- 于德介，程均經，洋宇，『機械故障診斷的Hilbert-Huang變換方法』，科學出版社

Independent Component Analysis

Independence and Correlation

- Correlation is a measurement of co-variation between x and y , depending on the first moment of joint pdf only. That is, x and y are said to be correlated if they are linearly or inverse linearly proportional to each other.
- Two signals x and y are said to be independent if and only if any transformation of x and y yields no correlation.
- Independence implies no correlation.
- Example: longevity and inflation are independent.

Two independent sources

S1

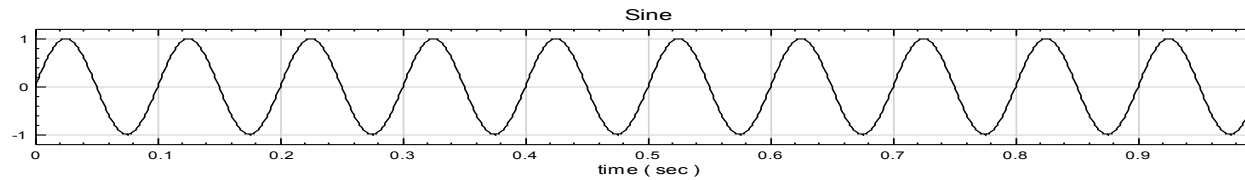

S2

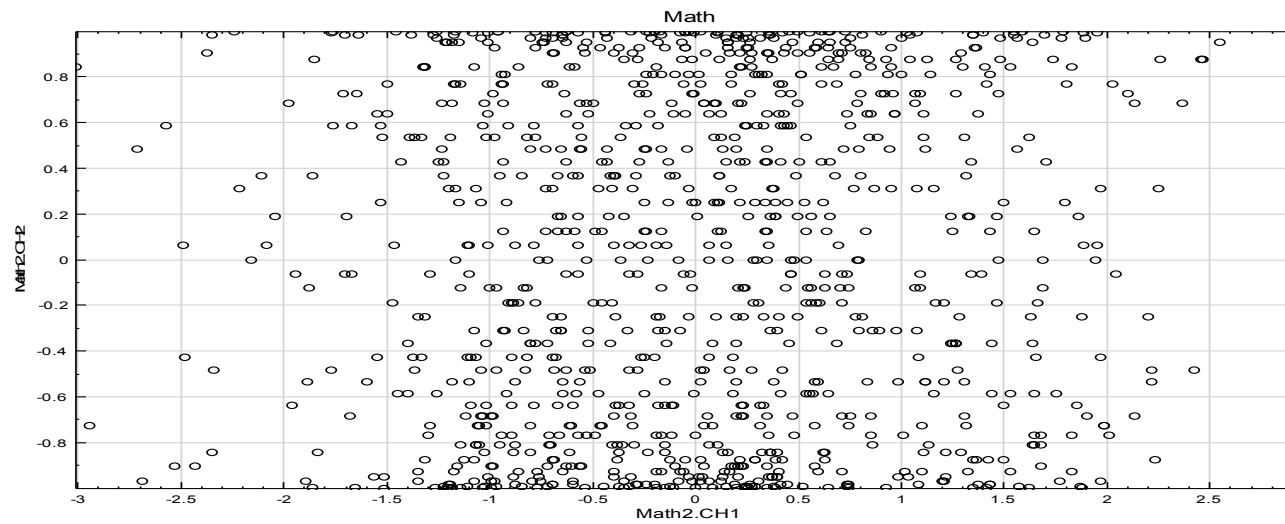
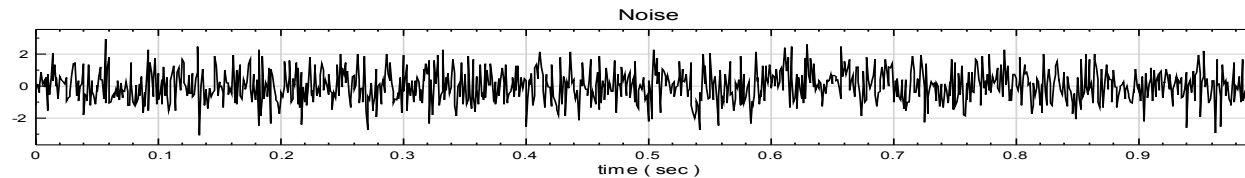

$$P(x,y)=P(x)*P(y)$$

Central Limit Theorem (A. Liapunov in 1901)

If a set of signals $s_j(t)$ are independent,
with means and variances m_j, σ_j^2

Then for a large number of M , the signal

$$x(t) = \sum_{j=1}^M s_j(t)$$

has a pdf which is approximately gaussian with mean $m = \sum_{j=1}^M m_j$

and variance $\sigma = \sum_{j=1}^M \sigma_j^2$

Kurtosis: a measure of gaussianality

- Gaussian distribution has zero Kurtosis.
- Kurtosis is a measure of gaussianality.

$$E[x^2] = \int_{x=-\infty}^{+\infty} p_x(x) x^2 dx$$

$$E[x^4] = \int_{x=-\infty}^{+\infty} p_x(x) x^4 dx$$

$$K = \frac{E[x^4]}{E[x^2]^2} - 3$$

Mixed signals

$$X1(t)=S1(t)+S2(t)$$

$$X2(t)=2*S1(t)-S2(t)$$

Mixed signals are correlated. That is, X1 and X2 are somehow related. As shown in the bottom plot, X1 and X2 are distributed in a way that increase of X1 implies the increase of X2.

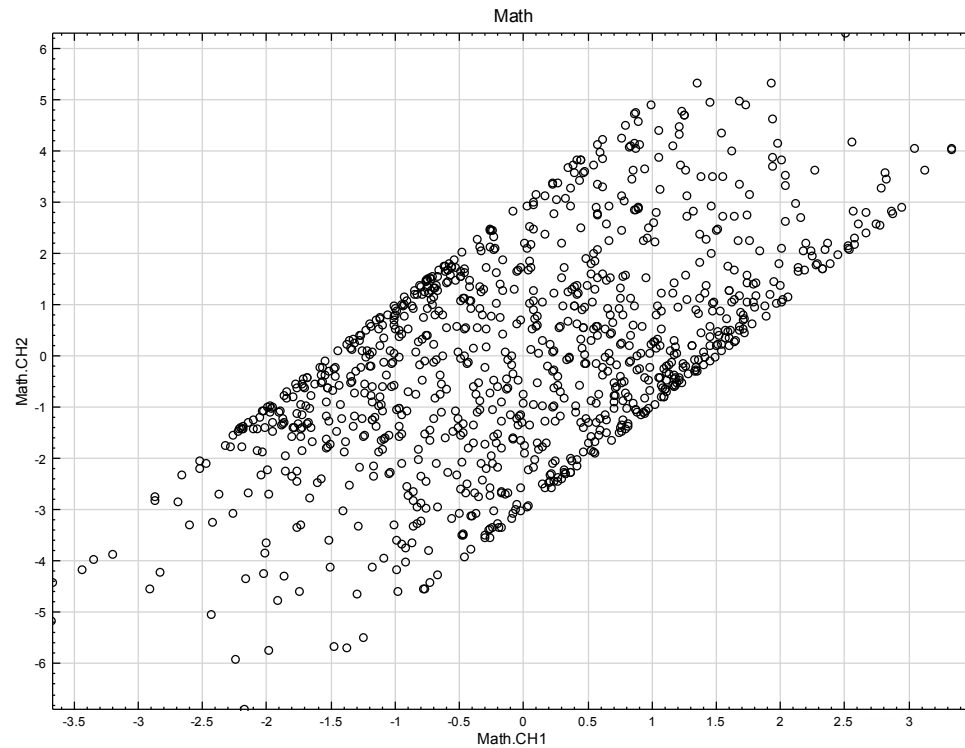
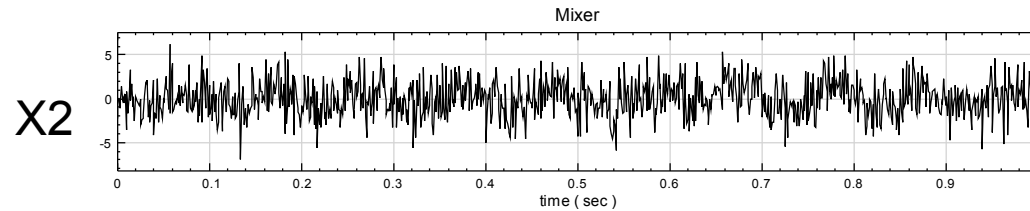
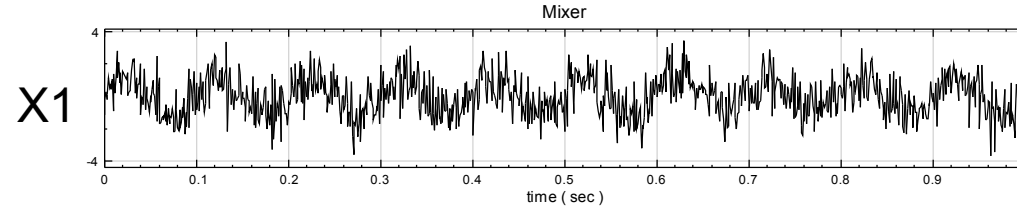

After ICA

After ICA, independent sources are recovered. The process is as followed:

$$X = A S$$

$$Y = B X$$

Where

$$AB \sim I$$

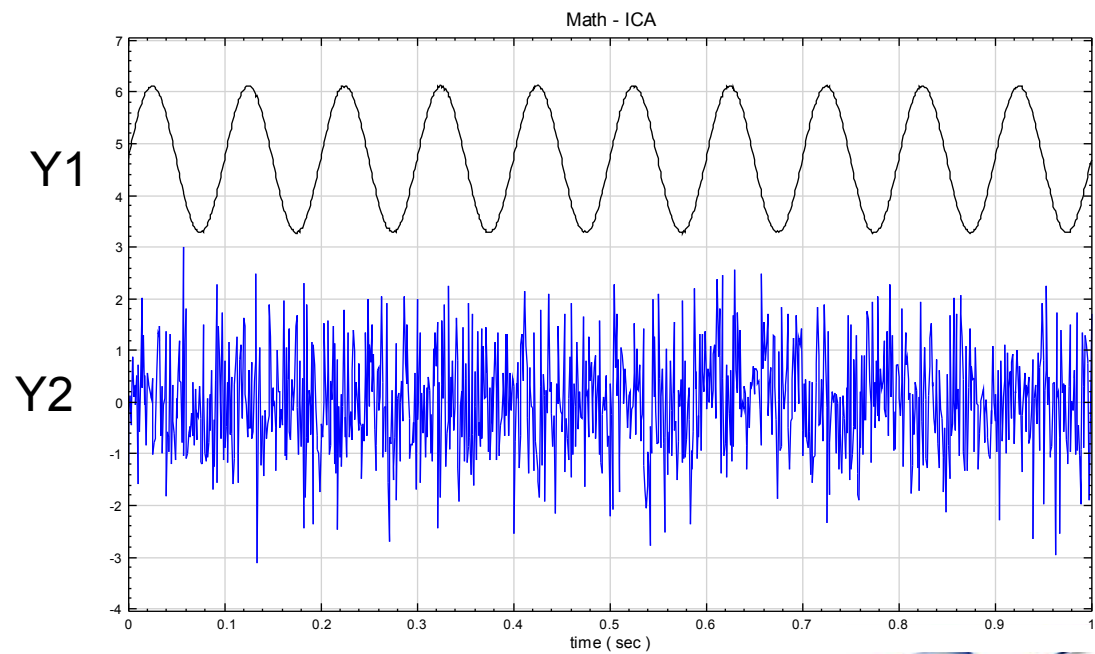
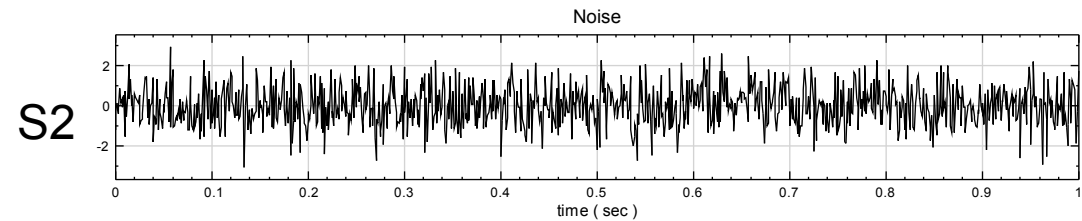
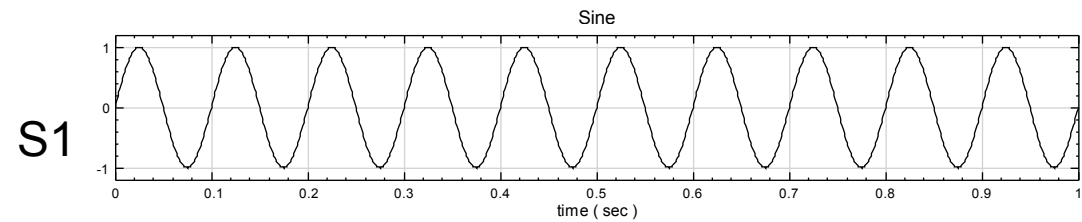

The idea

- Assume sources are independent.
- Any linear superposition of sources results in signal with more gaussianity as can be measured by Kurkosis.
- Applying linear superposition of mixed signals is the same as an operation of linear superposition of the source signals, though the sources signal are unknown.
- The signal with least gaussianity obtained from linear superposition of mixed signals correlates the most to one of the independent sources.

Thank you!

